



il tuo punto fermo

porte
DECORATI





OLMO ARTICO	pag _ 016
OLMO BALTICO	pag _ 026
OLMO DESERTO	pag _ 036
BIANCO SCULTURA	pag _ 046
BIANCO	pag _ 056
BIANCO FRASSINO	pag _ 066
ROVERE PROVENZA 3D	pag _ 076
ROVERE CITY 3D	pag _ 086
ROVERE MOCACCINO 3D	pag _ 096
ROVERE NATURALE 3D	pag _ 106
ROVERE MOKA 3D	pag _ 114
LINO DELAVÉ 3D	pag _ 124
WENGÉ	pag _ 132
NOCE NAZIONALE	pag _ 140
MANIGLIE HANDLES POIGNÉES MANIJAS РУЧКИ	pag _ 148
GAMMA COLORI COLOR RANGE GAMME DE COULEURS RANGO DE COLORES ЦВЕТОВАЯ ГАММА	pag _ 150
INSERTI INSERTS INSERTS INSERTOS МОЉДИНГИ	pag _ 151
VETRI GLASSES VITRAGES VIDRIOS СТÉКЛА	pag _ 152
TELAJ DOOR FRAMES CADRES DE PORTES MARCOS КОРОБА	pag _ 154





L'ECCELLENZA CHE VIENE DALL'ESPERIENZA

Una tradizione che dura dal 1963, da quando il giovane falegname Amerigo Pellegrini aprì un piccolo laboratorio per realizzare porte e finestre in legno. Negli anni la crescita è stata esponenziale, partendo dalla profonda conoscenza della materia prima e delle tecniche di lavorazione, diventate oggi la forza di un'azienda conosciuta in Italia e all'estero. In più di 50 anni Pail ha saputo coltivare il proprio "sapere", basando la propria attività sul coinvolgimento della famiglia, che oggi dirige le differenti divisioni aziendali dislocate nei 100 mila mq (45 mila mq coperti) dei quattro stabilimenti.

THE EXCELLENCE THAT COMES FROM EXPERIENCE

A tradition that has been going on since 1963, when the young joiner Amerigo Pellegrini opened a small workshop to make wooden doors and windows. Over the years, the growth has been exponential, starting from the deep knowledge of raw materials and processing techniques, that have become the strength of a company known in Italy and abroad. In more than 50 years Pail has been able to deepen its knowledge, basing its activities on the involvement of the family, who now directs the different divisions located in the 100 thousand square meters (45,000 square meters fully covered) of the four company plants.

L'EXCELLENCE QUI VIENT DE L'EXPÉRIENCE

Une tradition qui dure depuis 1963, lorsque le jeune menuisier Amerigo Pellegrini a ouvert un petit atelier pour fabriquer des portes et fenêtres en bois. Au fil des ans, la croissance a été exponentielle, à partir de la profonde connaissance des matières premières et des techniques de transformation, devenues maintenant la force d'une société connue en Italie et à l'étranger. En plus de 50 ans Pail a été en mesure d'approfondir leur propre «savoir faire», en fondant ses activités sur la participation de la famille, qui dirige maintenant les différentes unités de l'entreprise situées dans les 100 000 mètres carrés (45 000 mètres carrés couverts) des quatre établissements commerciaux.

LA EXCELENCIA QUE LLEGA DE LA EXPERIENCIA

Una tradición que empieza del 1963, desde cuando el joven carpintero Amerigo Pellegrini abrió una pequeña oficina para hacer puertas y ventanas de madera. Con los años, el crecimiento ha sido exponencial, a partir del profundo conocimiento de las materias primas y las técnicas de procesamiento, ahora convertidas en la fuerza de una empresa conocida en Italia como en el extranjero. En más de 50 años Pail ha sido capaz de aumentar su propio "saber", basando sus actividades en la participación de la familia, que hoy dirige las diferentes divisiones de la empresa repartidas en 100 mil metros cuadrados (45 mil mc cubiertos) en cuatro establecimientos.

ПРЕВОСХОДСТВО, КОТОРОЕ ПРИХОДИТ С ОПЫТОМ

Это традиция, зародившаяся еще в 1963, когда молодой столяр Америго Пеллегрини открыл маленькую ремесленную лабораторию для создания дверей и окон из дерева. За годы предприятие росло в экспоненциальном порядке, базируясь всегда на превосходном знании сырья и техник обработки дерева, и на сегодняшний день оно превратилось в гигант, известный как в Италии, так и за рубежом. За более, чем 50 лет, Pail сумели довести филигранно обработать и усовершенствовать накопленные «знания», закрепляя свою деятельность вовлечением в нее членов Семьи Пеллегрини, которые вплоть до сегодняшнего дня управляют всеми подразделениями предприятия, которое занимает 100 тысяч квадратных метров (45 тысяч метров это крытые помещения) и состоит из 4-х заводов предприятия.





PRODUZIONE INTERNA PER UNA QUALITÀ TOTALE

Dalla fase di progettazione dei modelli alla produzione, dalle lavorazioni di finitura fino all'imballaggio, l'azienda è in grado di gestire internamente l'intero processo, curando costantemente il passaggio da un reparto all'altro, per una garanzia di qualità totale. La produzione interna si esprime anche a livello tecnico: telai in listellare e mostre in multistrato vengono realizzati in azienda e lavorati con colla poliuretanic, dando vita a prodotti capaci di resistere perfettamente a calore e umidità.

INTERNAL PRODUCTION FOR TOTAL QUALITY

Starting from design to production of the models, from finishing processes to packaging, the company is able to manage internally the entire process, constantly taking care of the transition between one department to another, for a full quality assurance. The internal production cycle is based on high technical level: veneered blockboard door frames, multilayer wood board architraves are made internally and processed with polyurethane glue, creating products that resist heat and humidity perfectly.

PRODUCTION INTERNE POUR UNE QUALITÉ TOTALE

De la conception à la production des modèles, du processus de finition à l'emballage, la société est en mesure de gérer soi-même l'ensemble du processus, en prenant constamment soin de la transition d'un département à l'autre, pour une assurance qualité complète. Le cycle de production interne est basée sur un haut niveau technique: cadres porte en panneau latté plaqués et couvre-joints de contreplaqué sont fabriqués directement par la société et sont traités avec de la colle polyuréthane, ce qui nous donne de produits qui résistent parfaitement à la chaleur et à l'humidité.

PRODUCCIÓN INTERNA PARA UNA CALIDAD TOTAL

Desde la proyectación de los modelos hasta la producción, desde los procesos de acabado al embalaje, la empresa puede gestionar internamente todo el proceso, teniendo cuidado constantemente del pasaje de un departamento a otro, para una garantía total de la calidad. La producción interna se expresa también a nivel técnico: marcos de madera contrachapada y molduras de madera multicapa se realizan en la empresa y se tratan con cola de poliuretano, creando productos capaces de resistir perfectamente al calor y la humedad.

ВНУТРЕННЕ ПРОИЗВОДСТВО ДЛЯ ЛУЧШЕГО КАЧЕСТВА

Начиная с фазы проектирования моделей до самого процесса производства, от процесса получения нужной отделки до этапа упаковки товара предприятие в состоянии полностью обеспечить весь производственный процесс, осуществляя непрерывный контроль при перемещении товара из одного цеха в другой, таким образом обеспечивая полный контроль качества товара. Внутренне производство проявляется также и на техническом уровне: коробка из многослойного массива и наличники из фанеры изготавливаются внутри предприятия, обрабатываются полиуретановым клеем, давая жизнь изделиям устойчивым к изменениям температуры и уровня влажности.

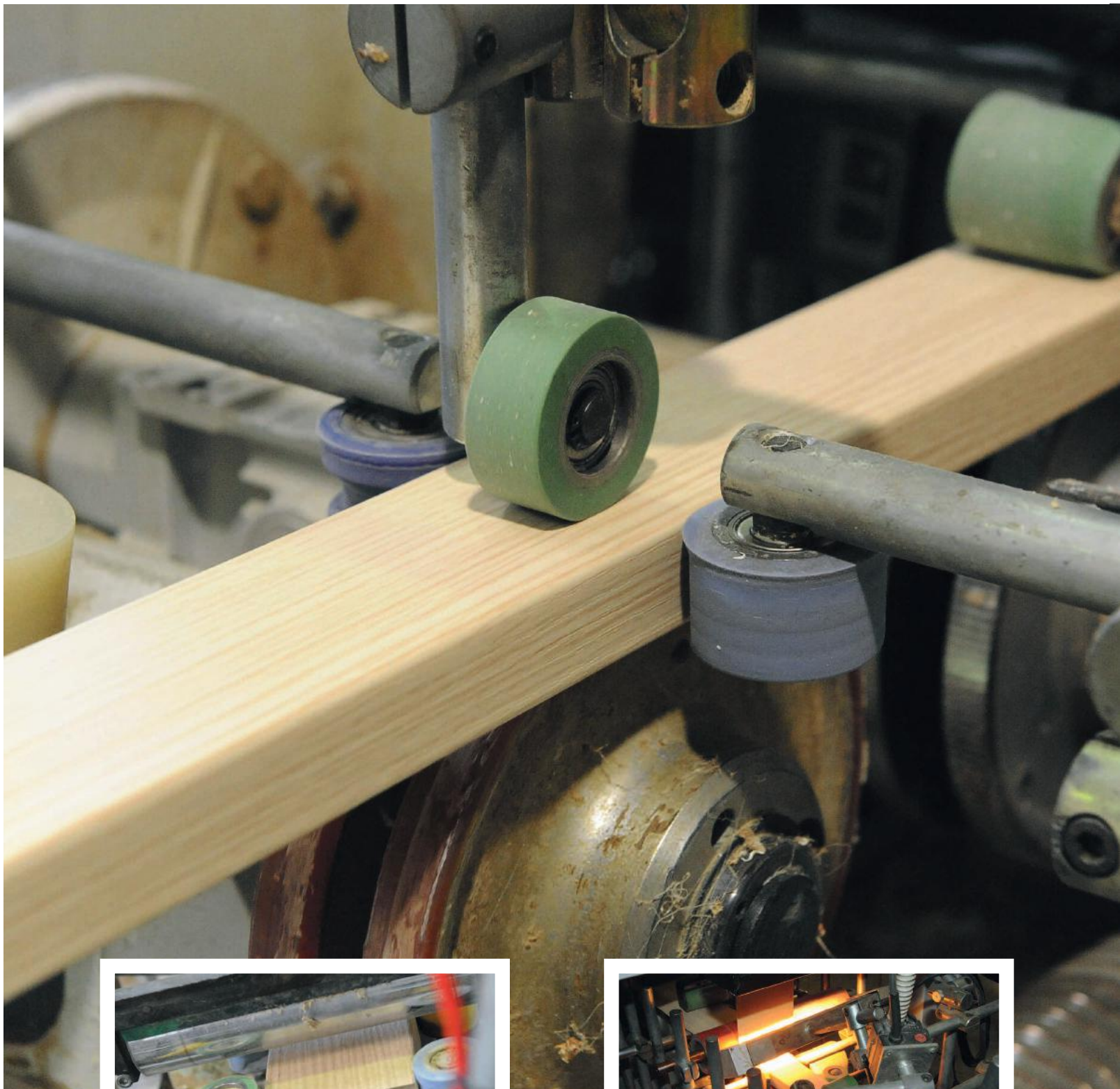

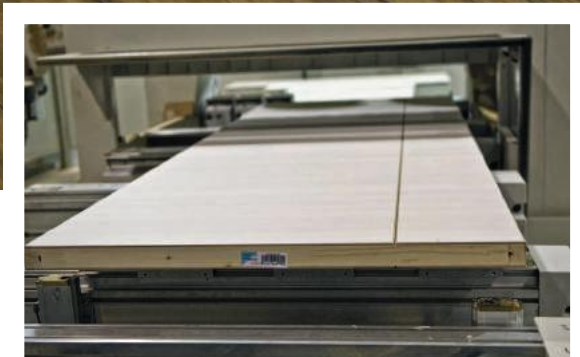

PAROLA D'ORDINE: INNOVAZIONE

La cura artigianale dei dettagli e l'uso di lavorazioni innovative creano prodotti inimitabili, realizzati da un'azienda che è alla continua ricerca di evoluzioni tecniche e strutturali per offrire al mercato porte che siano sempre un passo avanti. Ultima novità firmata Pail è il perfetto abbinamento di pannelli decorati orientati diversamente, che creano linee e forme geometriche di grande impatto. Altra lavorazione esclusiva è la particolare bordatura soft di ogni porta, che garantisce un risultato estetico impeccabile, eliminando spigoli e giunzioni.

KEY WORD: INNOVATION

The craftsmanship of the details and the use of innovative processes create inimitable products, made by a company that is always looking for innovative technical and structural solutions in order to provide doors that are always one step ahead. Last novelty signed by Pail is the perfect assembly of decorated panels with wood grain oriented differently, that create lines and geometric shapes of great impact. Another exclusive processing is the special soft edge of each door, which guarantees a flawless appearance, eliminating corners and junctions.

MOT DE PASSÉ: INNOVATION

L'artisanat des détails et l'utilisation de procédés innovants créent des produits inimitables, faites par une entreprise qui est toujours à la recherche de solutions techniques et structurelles innovantes afin de fournir des portes qui sont toujours une longueur d'avance.

Dernière nouveauté signée par Pail est l'assemblage parfait des panneaux décorés avec grain de bois orientées différemment, qui créent des lignes et des formes géométriques de grand impact. Autre transformation spéciale exclusive est le bord doux de chaque porte, qui garantit un aspect impeccable et l'élimination des coins et jonctions.

CONTRASEÑA: INNOVACIÓN

El cuidado artesanal de los detalles y el uso de procesos innovadores crean productos inimitables realizados por una empresa que siempre busca el progreso técnico y estructural para ofrecer al mercado puertas que están siempre en primera línea. Última novedad de Pail es la combinación perfecta de paneles decorados con líneas diferentes que crean formas geométricas de gran efecto. Otro proceso exclusivo es el borde suave de cada puerta, lo que garantiza un aspecto impecable, eliminando esquinas y cruces.

КЛЮЧЕВОЕ СЛОВО: ИННОВАЦИИ

Ремесленная обработка деталей и использование инновационных разработок приводят к созданию неповторимого продукта. Предприятие-изготовитель в свою очередь находится в непрерывном поиске для технического и структурного эволюционирования, чтобы всегда иметь возможность предложить на рынок двери, которые на шаг впереди остальных. Последнее новшество Pail – это использование панелей коллекции Decorati, которые создают различные геометрические линии и формы. Другой эксклюзивной особенностью является новый способ торцевания дверей, который называется bordatura soft, и который обеспечивает безупречный эстетический результат, устраняя все виды кромок, углов или видимых соединений.



A SOSTEGNO DELL'AMBIENTE

L'attenzione per il territorio e per le sue risorse rivestono un ruolo di primo piano nella mission di Pail, che da anni ha adottato il sistema di gestione per la qualità certificato a norma UNI EN ISO 9001 e il sistema di gestione ambientale certificato a norma UNI EN ISO 14001, come strumenti volontari di autocontrollo e responsabilizzazione. A questi si aggiunge un importante impianto fotovoltaico presente sugli stabilimenti aziendali, che permette di ridurre l'impatto energetico.

TO SUPPORT THE ENVIRONMENT

The attention to the territory and its resources play a prominent role in the mission of Pail, who for years has adopted the system of quality management certified according to UNI EN ISO 9001 and the environmental management system certified under UNI EN ISO 14001, as voluntary tools of self-control and own responsibility. Added to this is an important photovoltaic system on its company buildings, which reduces the energy impact.

EN FAVEUR DE L'ENVIRONNEMENT

L'attention au territoire et à ses ressources joue un rôle de premier plan dans la mission de Pail, qui pendant des années a adopté le système de gestion de la qualité certifié selon la norme UNI EN ISO 9001 et le système de management environnemental certifié UNI EN ISO 14001, comme outils volontaire pour l'autocontrôle et pour se responsabiliser. Ajouté à cela, un système photovoltaïque important positionné sur les immeubles de la société, ce qui réduit l'impact énergétique.

EN APOYO DEL MEDIO AMBIENTE

La atención por el territorio y sus recursos desempeñan un papel importante en la misión de Pail que durante años ha adoptado el sistema de gestión de calidad certificado según la norma UNI EN ISO 9001 y el sistema de gestión ambiental certificado según la norma UNI EN ISO 14001 como instrumentos voluntarios de auto-control y empoderamiento. Añadido a estos es un sistema fotovoltaico importante en los establecimientos, que permite reducir el impacto energético.

ДЛЯ ЗАЩИТЫ ОКРУЖАЮЩЕЙ СРЕДЫ

Внимание к окружающей среде и природным ресурсам всегда было для фабрики Pail одним из основополагающих факторов, поэтому в организации своей работы все предусмотрено с целью соблюдения европейских норм качества UNI EN ISO 9001, а также норм по охране окружающей среды UNI EN ISO 14001. Это свидетельствует о высокой степени ответственности руководства компании. Помимо этого, стоит сказать о наличии на фабрике фотогальванического оборудования, позволяющего фабрике сократить энергозатраты.





 MADE IN ITALY

DESIGN ITALIANO

Da cosa nasce il made in Italy firmato Pail? Dal giusto dosaggio di creatività, esperienza e manualità. Il percorso che porta alla realizzazione di ogni modello Pail è lungo e minuzioso: l'ideazione e la progettazione tecnica sono affidate a esperti designer italiani; la trasformazione del disegno in prodotto è il compito che il nostro personale qualificato, addestrato tecnicamente e con una grande esperienza nel settore, oggi in grado di rendere reale qualsiasi progetto.

ITALIAN DESIGN

Where does the made in Italy signed by Pail comes from? From the right dose of creativity, experience and skill. The path leading to the creation of each Pail's model is long and meticulous: the design and technical conception are handled by experienced Italian designers; the transformation of the drawing into the finished product is the task of our qualified staff, technically trained and with a great experience in the field, able to make real any project.

DESIGN ITALIEN

Qu'est-ce qui rend le made in Italy signé Pail unique? Une bonne dose de créativité, expérience et compétences. Le chemin qui mène à la création de chaque modèle Pail est long et minutieux : le design et la conception technique sont gérés par des designers italiens expérimentés la transformation du dessin dans le produit fini est la tâche de notre personnel qualifié, formé techniquement et avec une grande expérience dans le domaine, capable de faire tout projet réel.

DISEÑO ITALIANO

¿De donde viene el made in Italy firmado Pail? A partir de la dosis correcta de creatividad, experiencia y habilidad. El camino que conduce a la creación de cada modelo Pail es largo y detallado: el diseño y el diseño técnico son manejados por los diseñadores italianos expertos ; la transformación del dibujo en producto es el trabajo de nuestro personal calificado, capacitado técnicamente y con una gran experiencia en el campo, ahora capaz de hacer cualquier proyecto real.

ИТАЛЬЯНСКИЙ ДИЗАЙН

Из чего рождается марка made in Italy с эмблемой Pail? Из корректного сочетания креативности, опыта и присутствия ручной работы. Путь к созданию каждой модели Pail всегда длинный и очень кропотливый: идея создания и техническое проектирование доверяется всегда известным итальянским дизайнерам, а трансформация из рисунка в изделие - это уже задача нашего квалифицированного персонала, регулярно повышающего свою техническую квалификацию, который на сегодняшний день в состоянии реализовать проект любой сложности.

Olmo Artico

Un colore-non colore dai toni neutri che si combina con le leggere sfumature grigio ghiaccio che emergono dal fondo chiaro, creando un dinamismo senza eccessi.

A neutral tones colour that combines with the light ice gray shades emerging from the bright background, creating a dynamism without excess.

Une couleur des tons neutres qui se combine avec les tons gris clair émergeant de l'arrière-plan brillant, créant un dynamisme sans excès.

Un color con tonos neutros que se combina con los tonos ligeros gris hielo que emergen de un fondo claro, creando un dinamismo sin excesos

Цвет-не цвет нейтральных оттенков, который сочетается лёгкими оттенками серого, выступающими рябью на белом фоне, создавая динамику без излишеств.



Olmo Artico
MS CIECA ETerea LINE
MS PLAIN LEAF ETerea-LINE FRAME
MS VANTAIL LISSE CADRE ETerea LINE
MS LISA MARCO ETerea LINE
MS ГЛУХАЯ ETerea LINE



Olmo Artico

- GEO 02 CIECA TELAIO DESIGN 2015
- GEO 02 PLAIN LEAF DESIGN 2015 FRAME
- GEO 02 VANTAIL LISSE CADRE DESIGN 2015
- GEO 02 LIŠA MARCO DESIGN 2015
- GEO 02 ГЛУХАЯ КОРОБЬ DESIGN 2015



Olmo Artico
MS VETRO SIMMETRICO TELAIO DESIGN 2015
MS SYMMETRIC GLASS LEAF DESIGN 2015 FRAME
MS VITRAGE SYMÉTRIQUE CADRE DESIGN 2015
MS VIDRIO SIMÉTRICO MARCO DESIGN 2015
MS CTEKAO SIMMETRICO KOPOB DESIGN 2015



Olmo Artico
GEO 03 CIECA TELAIO EVO
GEO 03 PLAIN LEAF EVO FRAME
GEO 03 VANTAIL LISSE CADRE EVO
GEO 03 LISA MARCO EVO
GEO 03 ГЛУХАЯ КОРОБ EVO

Un concentrato di natura nelle sfumature che richiamano i colori dei paesaggi artici



A concentration of natural shades that evoke the colours of the Arctic landscapes
Une concentré de teintes naturelles qui rappellent les couleurs des paysages arctiques
Una concentración de lo natural en los tonos que evocan los colores de los paisajes árticos
Концентрат природы в оттенках. Взывающих к краскам античных пейзажей



Olmo Artico

- GEO 01 CIECA TELAIO DESIGN 2015
- GEO 01 PLAIN LEAF DESIGN 2015 FRAME
- GEO 01 VANTAIL LISSE CADRE DESIGN 2015
- GEO 01 LISA MARCO DESIGN 2015
- GEO 01 ГЛУХАЯ КОРОБ DESIGN 2015



Olmo Artico



mod. MS



mod. RFX



mod. RPY



mod. DMT



mod. INF



mod. GEO 01



mod. GEO 02



mod. GEO 03



mod. GEO 04



mod. GEO 05



mod. GEO 06



mod. GEO 07



mod. GEO 08



mod. GEO 09

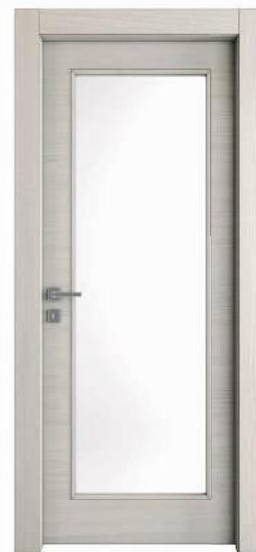

mod. VETRO STANDARD



mod. VETRO SIMMETRICO



mod. VETRO ASIMMETRICO



mod. VETRO SMALL
VETRO COMPLANARE

Olmo Baltico

Olmo Baltico

La predominanza di nuances di grigio conferisce al decorato olmo baltico un'austerità contemporanea basata sulla forza degli elementi naturali che ricorda.

The predominance of gray shades give to the decorated Baltic elm contemporary austerity based on the strength of the natural elements.

La prédominance des nuances de gris donne au décoré orme Baltique une austérité contemporaine basée sur la force des éléments naturels.

El predominio de los tonos grises da a este color una austeridad contemporánea basada en la fuerza de los elementos naturales que recuerdan.

Преобладание нюансов серого придаёт отделке decorato olmo baltico современную строгость, основанную на силе естественных элементов, которые она напоминает.



Olmo Baltico

- GEO 04 CIECA TELAIO EVO
- GEO 04 PLAIN LEAF EVO FRAME
- GEO 04 VANTAIL LISSE CADRE EVO
- GEO 04 LISA MARCO EVO
- GEO 04 ГЛУХАЯ КОРОБ EVO



Olmo Baltico

- MS CIECA TELAIO DESIGN 2015
- MS PLAIN LEAF DESIGN 2015 FRAME
- MS VANTAIL LISSE CADRE DESIGN 2015
- MS LISA MARCO DESIGN 2015
- MS ГЛУХАЯ КОРОБЬ DESIGN 2015



Olmo Baltico

MS CIECA SCORREVOLE INTERNO MURO MOSTRE SEMI FILO
MS PLAIN LEAF INTERNAL SLIDING DOOR SEMIFILO ARCHITRAVES
MS COULISSANTE INTERNE COUVRES JOINTS SEMIFILO
MS CORREDERA INTERIOR MOLDURAS SEMIFILO
MS ГЛУХАЯ КУПЕ В СТЕНУ НАЛИЧНИКИ ПОЛУКОПЛАНАРНЫЕ



Olmo Baltico

- GEO 09 CIECA TELAIO ETEREA LINE 2015
- GEO 09 PLAIN LEAF ETEREA LINE 2015 FRAME
- GEO 09 VANTAIL LISSE CADRE ETEREA LINE 2015
- GEO 09 LISA MARCO ETEREA LINE 2015
- GEO 09 ГЛУХАЯ КОРОБ ETEREA LINE 2015

La perfetta combinazione di diversi pannelli crea linee e geometrie



The perfect combination of different panels creates lines and shapes
La combinaison parfaite de plusieurs panneaux crée des lignes et des formes
La perfecta combinación de varios paneles crean líneas y formas
Совершенная комбинация различных панелей создают линии и геометрию



Olmo Baltico

- GEO 07 CIECA TELAIO EVO
- GEO 07 PLAIN LEAF EVO FRAME
- GEO 07 VANTAIL LISSE CADRE EVO
- GEO 07 LISA MARCO EVO
- GEO 07 ПЛУХАЯ КОРОБ EVO



Olmo Baltico
GEO 07 VETRO ASIMMETRICO
GEO 07 SYMMETRIC GLASS
GEO 07 VITRAGE SYMÉTRIQUE
GEO 07 VIDRIO SIMÉTRICO
GEO 07 CTEKΛO ASIMMETRICO

Olmo Baltico



mod. MS



mod. RFX



mod. RPY



mod. DMT



mod. INF



mod. GEO 01



mod. GEO 02



mod. GEO 03



mod. GEO 04



mod. GEO 05



mod. GEO 06



mod. GEO 07



mod. GEO 08



mod. GEO 09



mod. VETRO STANDARD



mod. VETRO SIMMETRICO



mod. VETRO ASIMMETRICO



mod. VETRO SMALL
VETRO COMPLANARE

Olmo Deserto

Tutta la gamma dei colori della sabbia è racchiusa nel decorato olmo deserto, che integra perfettamente tra loro i toni bruni freddi.

The whole range of the sand colours is contained in the decorated desert elm, which perfectly integrates among them the cold brown tones.

Toute la gamme des couleurs du sable est contenue dans le décoré orme désert, qui intègre parfaitement entre eux les tons bruns froid.

Toda la gama de colores de la arena está contenida en el decorado olmo deserto, que combina a la perfección los tonos marrones fríos.

Вся гамма оттенков песка собрана в отделке decorato olmo deserto, которая прекрасно дополняется холодными коричневыми тонами.



Olmo Deserto
GEO 01 TELAIO DESIGN 2015
GEO 01 DESIGN 2015 FRAME
GEO 01 CADRE DESIGN 2015
GEO 01 MARCO DESIGN 2015
GEO 01 KOPO5 DESIGN 2015



Olmo Deserto

- MS CIECA ETEREA LINE 2015
- MS PLAIN LEAF ETEREA LINE 2015 FRAME
- MS VANTAIL LISSE CADRE ETEREA LINE 2015
- MS LISA MARCO ETEREA LINE 2015
- MS ГЛУХАЯ ETEREA LINE 2015



Olmo Deserto

- MS CIECA SCORREVOLE MAGIC SLIDE
- MS PLAIN LEAF MAGIC SLIDE
- MS VANTAIL LISSE COULISSANTE MAGIC SLIDE
- MS LISA CORREDERA MAGIC SLIDE
- MS ГЛУХАЯ КУПЕ MAGIC SLIDE



Olmo Deserto.

- GEO 05 CIECA TELAIO DESIGN 2015
- GEO 05 PLAIN LEAF DESIGN 2015 FRAME
- GEO 05 VANTAIL LISSE CADRE DESIGN 2015
- GEO 05 LISA MARCO DESIGN 2015
- GEO 05 ГЛУХАЯ КОРОБЬ DESIGN 2015

Le gradazioni più fredde dei toni bruni

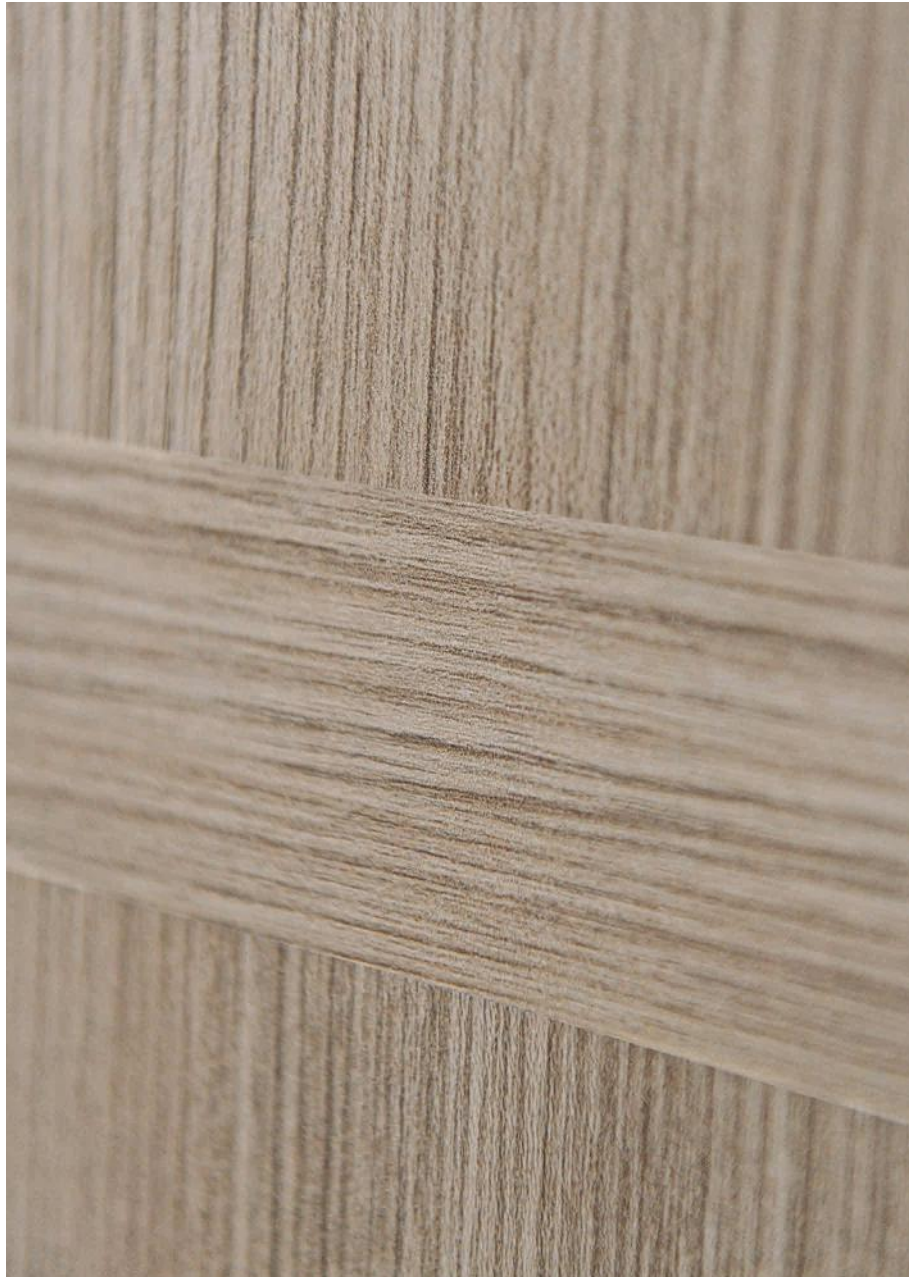

The coldest shades of brown tones
Les nuances les plus froides des tons bruns
Las gradaciones más frías de los tonos marrones
Градации более холодных оттенков коричневого



Olmo Deserto

GEO 08 CIECA TELAIO DESIGN 2015
GEO 08 PLAIN LEAF DESIGN 2015 FRAME
GEO 08 VANTAIL LISSE CADRE DESIGN 2015
GEO 08 LISA MARCO DESIGN 2015
GEO 08 ГЛУХАЯ КОРОБ DESIGN 2015



Olmo Deserto
GEO 08 CIECA SCORREVOLE ESTERNO MURO
GEO 08 PLAIN LEAF EXTERNAL SLIDING DOOR
GEO 08 VANTAIL LISSE COULISSANTE EXTÉRIEURE MUR
GEO 08 LISA CORREDERA EXTERIOR
GEO 08 ΓΛΥΧΗ ΚΥΠΕ ΕΣΤΡΕΝΟ ΜΥΡΟ

Olmo Deserto



mod. MS



mod. RFX



mod. RPY



mod. DMT



mod. INF



mod. GEO 01



mod. GEO 02



mod. GEO 03



mod. GEO 04



mod. GEO 05



mod. GEO 06



mod. GEO 07



mod. GEO 08



mod. GEO 09



mod. VETRO STANDARD



mod. VETRO SIMMETRICO



mod. VETRO ASIMMETRICO



mod. VETRO SMALL
VETRO COMPLANARE

Bianco Scultura

La purezza del bianco è esaltata e valorizzata dalle profonde striature del decorato bianco scultura, che si ispira alle venature del marmo grezzo.

The purity of the white is enhanced by deep stripes of white decorated sculpture, inspired by the grain of the rough marble.

La pureté du blanc est améliorée et renforcée par des rayures profondes de la sculpture blanche décorée, inspirés par le grain du marbre brut.

La pureza del blanco se potencia y mejora gracias a las estrías profundas del decorado blanco scultura, esta inspirado por las estrías del mármol en bruto.

Чистота белого возвышена и подчеркнута глубокими бороздками отделки decorato bianco scultura, на создание которой авторов вдохновил необработанный мрамор.



Bianco Scultura
RFX CIECA TELAIO EVO
RFX PLAIN LEAF EVO FRAME
RFX VANTAIL LISSE CADRE EVO
RFX LISA MARCO EVO
RFX ГЛУХАЯ КОРОБ EVO



Bianco Scultura

- DMT CIECA TELAIO EVO
- DMT PLAIN LEAF EVO FRAME
- DMT VANTAIL LISSE CADRE EVO
- DMT LISA MARCO EVO
- DMT ГЛУХАЯ КОРОБ EVO



Bianco Scultura

- DMT CIECA SCORREVOLE MAGIC SLIDE
- DMT PLAIN LEAF MAGIC SLIDE
- DMT VANTAIL LISSE COULISSANTE MAGIC SLIDE
- DMT LISA CORREDERA MAGIC SLIDE
- DMT ГЛУХАЯ КУПЕ MAGIC SLIDE



Bianco Scultura
MS TELAIO DESIGN 2015
MS DESIGN 2015 FRAME
MS CADRE DESIGN 2015
MS MARCO DESIGN 2015
MS ГЛУХАЯ КОРОБ DESIGN 2015

Profonde striature dall'effetto naturale e dall'impatto immediato



Deep stripes with natural effect and immediate impact
Rayures profondes à effet naturel et immédiat
Vetas profundas de impacto natural e inmediato
Глубокие бороздки с естественным эффектом и мгновенного действия



BORTE DECORATI



Bianco Scultura
RPY CIECA TELAIO DESIGN 2015
RPY PLAIN LEAF DESIGN 2015 FRAME
RPY VANTAIL LISSE CADRE DESIGN 2015
RPY LISA MARCO DESIGN 2015
RPY ГЛУХАЯ КОРОБ DESIGN 2015

Bianco Scultura





Bianco

La semplicità e l'eleganza del bianco lo rendono un colore senza tempo, adatto a rappresentare uno stile essenziale.

The simplicity and elegance of the white make it a timeless colour, suitable to represent an essential style.

La simplicité et l'élégance du blanc en font une couleur éternelle, apte à représenter un style essentiel.

La simplicidad y la elegancia del blanco hacen que sea un color atemporal, adecuado para representar un estilo esencial.

Простота и элегантность белого делают его цветом вне времени, который может с лёгкостью стать основой стиля.



Bianco

- LN CIECA TELAIO EVO
- LN PLAIN LEAF EVO FRAME
- LN VANTAIL LISSE CADRE EVO
- LN LISA MARCO EVO
- LN ГЛУХАЯ КОРОБ EVO



Bianco

- LN CIECA TELAIO EVO
- LN PLAIN LEAF EVO FRAME
- LN VANTAIL LISSE CADRE EVO
- LN LISA MARCO EVO
- LN ГЛУХАЯ КОРОБ EVO



Bianco

LN VETRO ASIMMETRICO TELAIO EVO
LN ASYMMETRIC GLASS EVO FRAME
LN VITRAGE ASYMETRIQUE CADRE EVO
LN VIDRIO ASIMÉTRICO MARCO EVO
LN CTEKΛO ASIMMETRICO KOP0B EVO



Bianco

LN CIECA CON INSERTI ORIZZONTALI 120 SCORREVOLE ESTERNO MURO
LN PLAIN LEAF HORIZONTAL INSERTS 120 EXTERNAL SLIDING DOOR
LN VANTAIL LISSE INSERTS HORIZONTALAUX COULISSANT EXTERNE DE 120
LN LISA INSERTOS HORIZONTALES CORREDERA EXTERIOR DE 120
LN ГЛУХАЯ С ГОРИЗОНТАЛЬНЫМ МОЛДИНГОМ 120 КУПЕ ПО СТЕНЕ

Minimale,
elegante e versatile
nella sua semplicità



Minimalist, elegant and versatile in its simplicity
Minimaliste, élégant et polyvalent dans sa simplicité
Minimalista, elegante y versátil en su simplicidad
Минимальный, элегантный и универсальный в своей простоте



Bianco

- RFX CIECA TELAIO ETHEREA LINE A TIRARE
- RFX PLAIN ETHEREA LINE FRAME (PULL)
- RFX VANTAIL LISSE CADRE ETHEREA LINE TIRER
- RFX LISA MARCO ETHEREA LINE TIRAR
- RFX ГЛУХАЯ КОРОБ ETHEREA LINE ОТКРЫВАНИЕ А ТИРАРЕ



Bianco
RFX CIECA TELAIO ETEREA LINE
RFX PLAIN ETEREA LINE FRAME(PUSH)
RFX VANTAIL LISSE CADRE ETEREA LINE POUSSER
RFX LISA MARCO ETEREA LINE EMPUJAR
RFX ПЛУХАЯ КОРОБ ETEREA LINE

Bianco





Bianco Frassino

La riproduzione dell'effetto poro aperto trasforma il bianco, aggiungendo ombre e diverse profondità percepibili anche al tatto.

The reproduction of the open pore effect turns white, adding shadows and different depths perceptible to the touch.

La reproduction de l'effet à pore ouvert devient blanc, ajoutant des ombres et des profondeurs différentes perceptibles au toucher.

La reproducción del efecto poro abierto vuelve el blanco,añadiendo sombras y diferentes profundidades perceptibles al tacto.

Воспроизведение эффекта дерева с открытыми порами трансформирует белый, добавляя в него тени и глубину, ощутимую даже на ощупь.



Bianco Frassino
DMT CIECA TELATO DESIGN 2015
DMT PLAIN LEAF FRAME DESIGN 2015
DMT VANTAIL LISSE CADRE DESIGN 2015
DMT LISA MARCÒ DESIGN 2015
DMT ТАУХАЯ КОПОБ DESIGN 2015



Bianco Frassino

MS VETRO SIMMETRICO SCORREVOLE INTERNO MURO DOPPIO MOSTRE SEMI FILO

MS SYMMETRIC GLASS INTERNAL DOUBLE SLIDING DOOR ARCHITRAVES SEMIFILO

MS VITRAGE SYMETRIQUE COULISSANTE DOUBLE COUVRES JOINTS SEMIFILO

MS VIDRIO SIMÉTRICO PUERTA CORREDERA DOBLE MOLDURAS SEMIFILO

MS СТЕКЛО СИММЕТРИКО КУПЕ В СТЕНУ 2 СТВ. НАЛИЧНИКИ ПОЛУКОПЛАНАРНЫЕ SEMI FILO



Bianco Frassino
MS CIECA TELAIO EVO
MS PLAIN LEAF EVO FRAME
MS LISSE CADRE EVO
MS LISA MARCO EVO
MS ТАУХАЯ КОРӨБ EVO



Bianco Frassino
MS CIECA TELAIO EVO
MS PLAIN LEAF EVO FRAME
MS VANTAIL LISSE CADRE EVO
MS LISA MARCO EVO
MS ГЛУХАЯ КОРОБ EVO

Le leggere venature dell'effetto poro aperto creano movimento in maniera discreta



The light wood grains with open pore effect create movement in with discretion
Les grains de bois légers avec effet pores ouverts créent du mouvement avec discrétion
Las ligeras vetas del efecto "poro abierto" crean movimiento discretamente
Легкие прожилки с эффектом открытых пор создают движение в умеренном темпе





Bianco Frassino

MS CON N. 1 INSERTO CENTRALE ORIZZONTALE TELAIO DESIGN 2015
MS WITH N.1 CENTRAL HORIZONTAL INSERT DESIGN 2015 FRAME
MS AVEC N.1 TRAVERSE CENTRALE HORIZONTAL CADRE DESIGN 2015
MS CON 1 INSERTO CENTRAL HORIZONTAL MARCO DESIGN 2015
MS C N. 1 ГОРИЗОНТАЛЬНЫЙ ПРОФИЛЬ ПО ЦЕНТРУ КОРОБ DESIGN 2015

Bianco Frassino





Rovere Provenza 3D

L'atmosfera semplice e accogliente dello stile provenzale è richiamata dal tradizionale effetto decapato delle tinte chiare opache.

The simple and cozy atmosphere of the Provençal style is recalled by the traditional decapé effect of the matte light colours.

L'atmosphère simple et chaleureuse du style provençal est rappelé par l'effet traditionnel du décapé sur les couleurs claires mat.

El ambiente sencillo y acogedor del estilo provenzal es revocado por el tradicional efecto blanqueado de los tonos claros.

Простая и уютная атмосфера провансальского стиля возвещается традиционным декапированным эффектом светлых матовых оттенков.



Rovere Provenza 3D
MS CIECA TELAIO EVO
MS PLAIN LEAF EVO FRAME
MS VANTAIL LISSE CADRE EVO
MS LISA MARCO EVO
MS ГЛУХАЯ КОРОБ EVO



Bovere Provenza 3D

MS CIECA CON N. 3 INSERTI ORIZZONTALI TELAIO DESIGN 2015

MS PLAIN LEAF WITH N.3 HORIZONTAL INSERTS DESIGN 2015 FRAME

MS VANTAIL LISSE AVEC N.3 TRAVERSES CENTRALES HORIZONTAL CADRE DESIGN 2015

MS LISA CON 3 INSERTOS CENTRALES HORIZONTALES MARCO DESIGN 2015

MS ГЛУХАЯ N. 3 ГОРИЗОНТАЛЬНЫХ ПРОФИЛЯ КОРОБ DESIGN 2015



Rovere Provenza 3D

MS CIECA CON N. 3 INSERTI ORIZZONTALI TELAIO SCORREVOLE INTERNO MURO MOSTRE SEMIFILO DA 100

MS PLAIN LEAF WITH N.3 HORIZONTAL INSERTS INTERNAL SLIDING DOOR SEMI-FLUSH ARCHITRAVES OF MM 100

MS VANTAIL LISSE AVEC N.3 TRAVERSES CENTRALES HORIZONTAL COULISSANTE A DISPARITION COUVRE-JOINTS SEMI-ALIGNÉS DE MM 100

MS LISA CON 3 INSERTOS CENTRALES HORIZONTALES PUERTA CORREDERA MOLDURAS SEMIFILO MM 100

MS ГЛУХАЯ N. 3 ГОРИЗОНТАЛЬНЫХ ПРОФИЛЯ КОРОБ КУПЕ В СТЕНУ MOSTRE SEMIFILO DA 100



Rovere Provenza 3D
GEO 05 CIECA TELAIO EVO
GEO 05 PLAIN LEAF EVO FRAME
GEO 05 VANTAIL LISSE CADRE EVO
GEO 05 LISA MARCO EVO
GEO 05 ГЛУХАЯ КОРОБ EVO

Il leggero effetto a rilievo si sposa con il colore chiaro del decapato provenzale



The slight raised effect perfectly combines with the light colour of the provençal decapé
L'effet léger de relief se combine parfaitement avec la couleur claire du décapé provençal
El efecto ligero de relieve se combina con el color claro del blanqueado provençal
Легкий эффект рельефности великолепно сочетается со светлым цветом decapato provençal





Rovere Provenza 3D
GEO 04 CIECA TELAIO DESIGN 2015
GEO 04 PLAIN LEAF DESIGN 2015 FRAME
GEO 04 VANTAIL LISSE CADRE DESIGN 2015
GEO 04 LISA MARCO DESIGN 2015
GEO 04 ГЛУХАЯ КОРОБЬ DESIGN 2015

Rovere Provenza 3D





mod. GEO 06



mod. GEO 07



mod. GEO 08



mod. GEO 09



mod. VETRO STANDARD



mod. VETRO SIMMETRICO



mod. VETRO ASIMMETRICO



mod. VETRO SMALL
VETRO COMPLANARE

Rovere City 3D

La linearità dell'effetto rovere esalta il chiaroscuro delle molteplici gradazioni di grigio e tortora, per uno stile contemporaneo e metropolitano.

The linearity of the oak effect enhances the contrast of the many shades of gray and tortora for a contemporary and metropolitan style.

La linéarité de l'effet chêne améliore le contraste des nombreuses nuances de gris et tortora pour un style contemporain et métropolitain.

La linealidad del efecto roble exalta el claroscuro de los muchos tonos de gris para un estilo contemporáneo y metropolitano.

Линейность эффекта дуба превозносит светло тёмные оттенки многочисленных градаций серого и бледно-коричневого, создавая современный стиль мегаполиса.



Rovere City 3D

GEO 01 CIECA TELAIO EVO
GEO 01 PLAIN LEAF EVO FRAME
GEO 01 VANTAIL LISSE CADRE EVO
GEO 01 LISA MARCO EVO
GEO 01 ГЛУХАЯ КОРОБ EVO



Rovere City 3D

GEO 07 CIECA TELAIO DESIGN 2015
GEO 07 PLAIN LEAF DESIGN 2015 FRAME
GEO 07 VANTAIL LISSE CADRE DESIGN 2015
GEO 07 LISA MARCO DESIGN 2015
GEO 07 ГЛУХАЯ КОРОБ DESIGN 2015

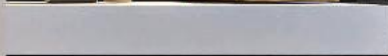

Rovere City 3D
GEO 07 VETRO SMALL TELAIO DESIGN 2015
GEO 07 SMALL GLASS DESIGN 2015 FRAME
GEO 07 VITRAGE SMALL CADRE DESIGN 2015
GEO 07 VIDRIO SMALL MARCO DESIGN 2015
GEO 07 CTEKΛO SMALL KOΠO5 DESIGN 2015



Rovere City 3D

- MS CIECA CON INSERTI ORIZZONTALI 200 TELAIO ETEREA LINE 2015
- MS PLAIN LEAF HORIZONTAL INSERTS 200 ETEREA LINE 2015 FRAME
- MS VANTAIL LISSE INSERTS HORIZONTALTALES 200 CADRE ETEREA LINE 2015
- MS LISA INSERTOS HORIZONTALES 200 MARCO ETEREA LINE 2015
- MS ГЛУХАЯ С ГОРИЗОНТАЛЬНЫМИ МОЛДИНГАМИ 200 КОРОБ ETEREA LINE 2015

Le gradazioni del grigio trasmettono austerità e contemporaneità



Shades of gray transmit austerity and contemporaneity
Les nuances de gris transmettent austérité et contemporanéité
Las tonalidades de gris transmiten austeridad y contemporaneidad
Оттенки серого передают резкость и современность



Rovere City 3D

- GEO 09 CIECA TELAIO STANDARD
- GEO 09 PLAIN LEAF STANDARD FRAME
- GEO 09 VANTAIL LISSE CADRE STANDARD
- GEO 09 LISA MARCO ESTÁNDAR
- GEO 09 ГЛУХАЯ КОРОБ СТАНДАРД



Rovere City 3D
GEO 09 CIECA VERSIONE ROTEA
GEO 09 PLAIN LEAF ROTEA VERSION
GEO 09 VANTAIL LISSE-ROTEA
GEO 09 LISA-ROTEA
GEO 09 ГЛУХАЯ ВЕРСИЯ ROTEA

Rovere City 3D



mod. MS



mod. RFX



mod. RPY



mod. DMT



mod. INF



mod. GEO 01



mod. GEO 02



mod. GEO 03



mod. GEO 04



mod. GEO 05



mod. GEO 06



mod. GEO 07



mod. GEO 08



mod. GEO 09



mod. VETRO STANDARD



mod. VETRO SIMMETRICO



mod. VETRO ASIMMETRICO



mod. VETRO SMALL
VETRO COMPLANARE

Rovere Mocaccino 3D

Rovere Mocaccino

Tutto il calore dei marroni è stemperato dalla presenza di una ricca gamma di grigi e di sabbia, per un effetto dinamico e moderno.

All the warmth of the brown is tempered by the presence of a rich range of grays and sand, for a dynamic and modern effect.

Toute la chaleur du brun est détrempée par la présence d'une riche gamme de gris et de sable, pour un effet dynamique et moderne.

Todo el calor de marrón está atenuado por la presencia de una rica gama de grises y arena, para un efecto dinámico y moderno.

Все тепло коричневого растворяется присутствием богатой гаммы серых и песочных оттенков, создавая динамический эффект современности.



Rovere Mocaccino 3D
GEO 03 CIECA TELAIO DESIGN 2015
GEO 03 PLAIN LEAF DESIGN 2015 FRAME
GEO 03 VANTAIL LISSE CADRE DESIGN 2015
GEO 03 LISA MARCO DESIGN 2015
GEO 03 ГЛУХАЯ КОРОБЬ DESIGN 2015



Rovere Mocaccino 3D

INF CIECA SCORREVOLE PARALLELO ESTERNO MURO

INF PLAIN LEAF PARALLEL SLIDING EXTERIOR WALL

INF VANTAIL LISSE COULISSANT PARALLÈLE EXTERNE MUR

INF LISA CORREDERA PARALELO EXTERNO

INF ГЛУХАЯ 2 СТВ КУПЕ ПО СТЕНЕ С ДВУХРЕЛЬСОВОЙ НАПРАВЛЯЮЩЕЙ



Rovere Mocaccino 3D
INF CIECA TELAIO STANDARD
INF PLAIN LEAF STANDARD FRAME
INF VANTAIL LISSE CADRE STANDARD
INF LISA MARCO ESTÁNDAR
INF ГЛУХАЯ КОРОБ STANDARD



Rovere Mocaccino 3D
GEO 01 CIECA TELAIO EVO
GEO 01 PLAIN LEAF EVO FRAME
GEO 01 VANTAIL LISSE CADRE EVO
GEO 01 LISA MARCO EVO
GEO 01 ГЛУХАЯ КОРОБ EVO

Un'altalena di striature verticali e orizzontali



A swing of the vertical and horizontal stripes
Une balançoire de rayures verticales et horizontales
Un intercambio de vetas verticales y horizontales
Череда вертикальных и горизонтальных бороздок





Rovere Mocaccino 3D

GEO 06 CIECA TELAIO DESIGN 2015

GEO 06 PLAIN LEAF DESIGN 2015 FRAME

GEO 06 VANTAIL LISSE CADRE DESIGN 2015

GEO 06 LISA MARCO DESIGN 2015

GEO 06 ГЛУХАЯ КОРОБ DESIGN 2015

Rovere Mocaccino 3D



mod. MS



mod. RFX



mod. RPY



mod. DMT



mod. INF



mod. GEO 01



mod. GEO 02



mod. GEO 03



mod. GEO 04



mod. GEO 05



mod. GEO 06



mod. GEO 07



mod. GEO 08



mod. GEO 09



mod. VETRO STANDARD



mod. VETRO SIMMETRICO



mod. VETRO ASIMMETRICO



mod. VETRO SMALL
VETRO COMPLANARE

Rovere Naturale 3D

Naturale 3D

Le tonalità calde del rovere e il tradizionale effetto striato creano un'ampia gradazione di colori che vanno dal giallo al bruno, con qualche venatura di grigio.

The warm tones of the oak and the traditional striped effect creates a wide scale of colours ranging from yellow to brown, with a vein of gray.

Les tons chauds du chêne et l'effet traditionnel à rayures créent une large gamme de couleurs allant du jaune au brun, avec une veine de gris.

Los tonos cálidos del roble y el tradicional efecto rayado crean una amplia gradación de colores que van del amarillo al marrón, con una vena de gris.

Тёплые тона дуба и традиционный эффект полос создают широкую гамму цветов, начиная от жёлтого до коричневого, с некоторыми прожилками серого.



Rovere Naturale 3D
MS CIECA TELAIO EVO
MS PLAIN LEAF EVO FRAME
MS VANTAIL LISSE CADRE EVO
MS LISA CUADRO EVO
MS ГЛУХАЯ КОРОБ EVO



Rovere Naturale 3D
GEO 08 CIECA TELAIO DESIGN 2015
GEO 08 PLAIN LEAF DESIGN 2015 FRAME
GEO 08 VANTAIL LISSE CADRE DESIGN 2015
GEO 08 LISA CUADRO DESIGN 2015
GEO 08 ГЛУХАЯ КОРОБ DESIGN 2015



Rovere Naturale 3D

GEO 08 CIECA VERSIONE NOVA LIBRA TELAIO STANDARD MOSTRE SEMI FILO
GEO 08 PLAIN LEAF NOVA LIBRA VERSION STANDARD FRAME SEMIFILO ARCHITRAVES
GEO 08 VANTAIL LISSE MODÈLE NOVA LIBRA CADRE STANDARD COUVRES JOINTS SEMIFILO
GEO 08 LISA VERSION NOVA LIBRA CUADRO ESTÁNDAR MOLDURAS SEMIFILO
GEO 08 ГЛУХАЯ ВЕРСИЯ NOVA LIBRA КОРОБ STANDARD НАЛИЧНИКИ ПОЛУКОМПЛАНАРНЫЕ SEMI FILO



Rovere Naturale 3D
GEO 01 CIECA TELAIO DESIGN 2015
GEO 01 PLAIN LEAF DESIGN 2015 FRAME
GEO 01 VANTAIL LISSE CADRE DESIGN 2015
GEO 01 LISA CUADRO DESIGN 2015
GEO 01 ГЛУХАЯ КОРОБ DESIGN 2015

Una gamma di colori caldi che scaldano ogni ambiente



A range of warm colours that warm any space
Une gamme de couleurs chaudes qui réchauffent n'importe quelle pièce
Una gama de colores cálidos que calienta cualquier habitación
Гамма теплых оттенков, которые согреют любой интерьер

Rovere Naturale 3D



mod. MS



mod. RFX



mod. RPY



mod. DMT



mod. INF



mod. GEO 01



mod. GEO 02



mod. GEO 03



mod. GEO 04



mod. GEO 05



mod. GEO 06



mod. GEO 07



mod. GEO 08



mod. GEO 09



mod. VETRO STANDARD



mod. VETRO SIMMETRICO



mod. VETRO ASIMMETRICO



mod. VETRO SMALL
VETRO COMPLANARE

Rovere Moka 3D

Rovere Moka

Le ampie striature scure del decorato rovere Moka lasciano spazio a lievi presenze di altre tonalità, esaltando talvolta i neri e talvolta i chiari tendenti al giallo.

The large dark stripes of the decorated oak give way to slight presence of other tones, sometimes enhancing the blacks and sometimes the clear yellowish.

Les larges rayures sombres du décoré chêne cèdent la place à une légère présence d'autres tonalités, parfois renforcer les noirs et parfois le jaune clair.

Las grandes rayas oscuras del decorado roble dan paso a una ligera presencia de otros tonos, a veces enfatizando los negros y a veces el claro amarillento.

Широкие темные рельефные полосы отделки decorato rovere оставляют место для синтеза с легким присутствием оттенков других тоналностей, превознося порой черные, порой светлые, стремящиеся к желтому цветовые оттенки.



Rovere Moka 3D
MS VETRO VERSIONE PIEGA
MS GLASS LEAF PIEGA VERSION
MS VITRAGE-PIEGA
MS VIDRIO-PIEGA
MS СТЕКЛО ВЕРСИЯ PIEGA



Rovere Moka 3D

GEO 08 CIECA TELAIO DESIGN 2015
GEO 08 PLAIN LEAF DESIGN 2015 FRAME
GEO 08 VANTAIL LISSE CADRE DESIGN 2015
GEO 08 LISA MARCO DESIGN 2015
GEO 08 ГЛУХАЯ КОРОБ DESIGN 2015



Rovere Moka 3D
GEO 08/INF VETRO SIMMETRICO SCORREVOLE PARALLELO
GEO 08/INF SYMMETRIC GLASS PARALLEL SLIDING DOOR
GEO 08/INF VITRAGE SYMMETRIQUE COULISSANT PARALLELE
GEO 08/INF VIDRIO SIMÉTRICO PUERTA CORREDERA PARALELA
GEO 08/INF CTEKAO SIMMETRICO KYNE B PROEME



Rovere Moka 3D
GEO 05 CIECA TELAIO EVO
GEO 05 PLAIN LEAF EVO FRAME
GEO 05 VANTAIL LISSE CADRE EVO
GEO 05 LISA MARCO EVO
GEO 05 ГЛУХАЯ КОРОБ EVO

Leggere alternanze di colore
esaltano
le venature scure

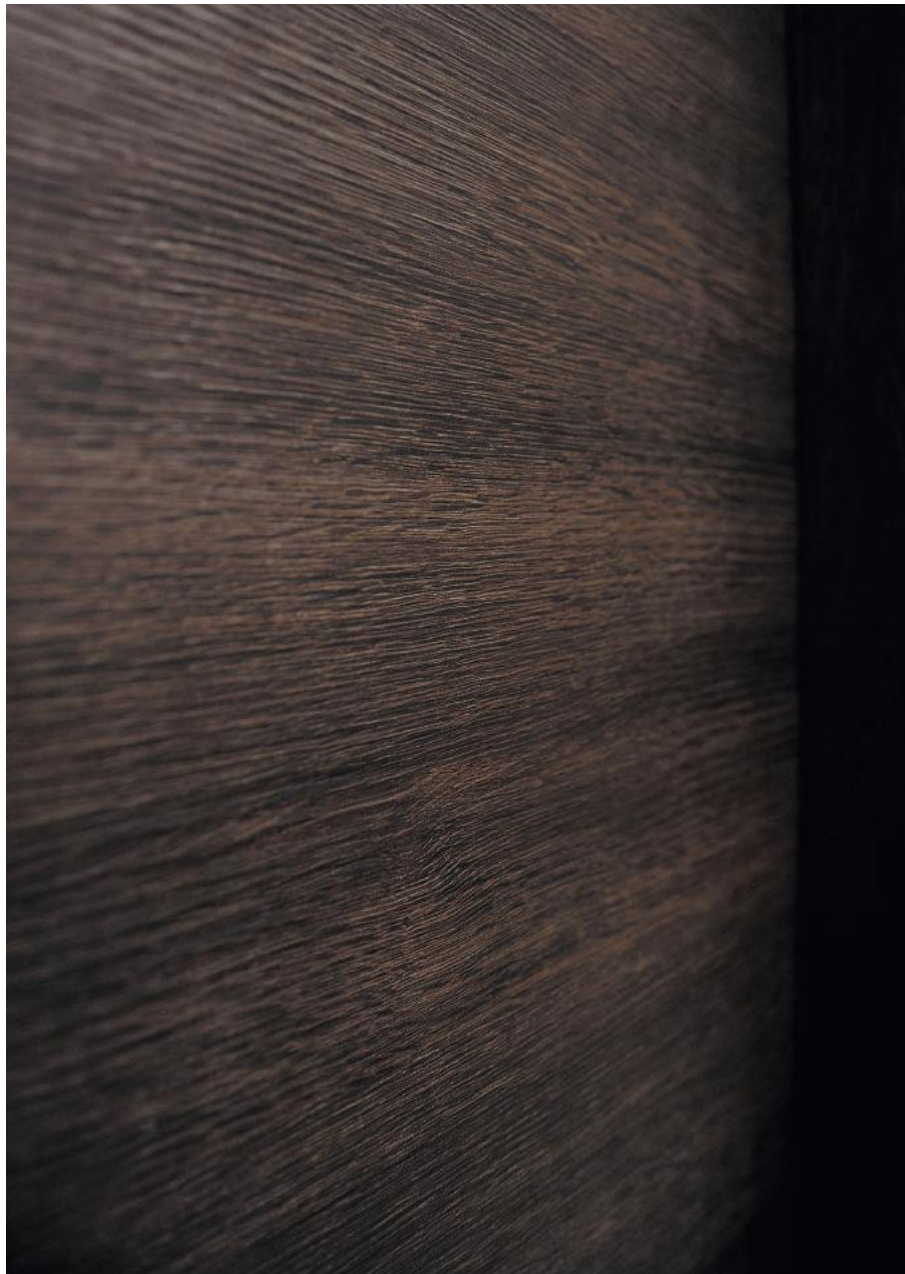

Light alternations of colour enhance the dark wood grain
Légères alternances de couleur accentuent les grains du bois sombres
Las ligeras alternancia de color realzan las rayas oscuras
Прочсть чередование цвета, выделяя темные прожилки



Rovere Moka 3D

MS CON N.2 INSERTI ORIZZONTALI SCORREVOLE MAGIC SLIDE
MS WITH N.2 HORIZONTAL INSERTS SLIDING MAGIC SLIDE
MS AVEC N.2 TRAVERSES HORIZONTALES COULISSANTE MAGIC SLIDE
MS CON 2 INSERTOS HORIZONTALES CORREDERA MAGIC SLIDE
MS N.2 ГОРИЗОНТАЛЬНЫХ ПРОФИЛЯ КУПЕ MAGIC SLIDE



Rovere Moka 3D

MS CON N.2 INSERTI ORIZZONTALI TELAIO DESIGN 2015
MS WITH N.2 HORIZONTAL INSERTS STANDARD FRAME 2015
MS AVEC N.2 TRAVERSES HORIZONTALES CADRE STANDARD 2015
MS CON 2 INSERTOS HORIZONTALES MARCO ESTÁNDAR 2015
MS N.2 ГОРИЗОНТАЛЬНЫХ ПРОФИЛЯ КОРОБ DESIGN 2015

Rovere Moka 3D



mod. MS



mod. RFX



mod. RPY



mod. DMT



mod. INF



mod. GEO 01



mod. GEO 02



mod. GEO 03



mod. GEO 04



mod. GEO 05



mod. GEO 06



mod. GEO 07



mod. GEO 08



mod. GEO 09



mod. VETRO STANDARD



mod. VETRO SIMMETRICO



mod. VETRO ASIMMETRICO



mod. VETRO SMALL
VETRO COMPLANARE

Lino Delavé 3D

Una combinazione di effetti visivi e tattili che riproduce la sovrapposizione di legno e tessuto. Le trame e i colori sono tenui e naturali come il colore del lino non trattato.

A combination of visual and tactile effects that reproduces the overlap of wood and fabric. Textures and colours are soft and natural as the colour of the untreated linen.

Une combinaison d'effets visuels et tactiles qui reproduit le chevauchement de bois et d'un tissu. Textures et couleurs sont douces et naturelles comme la couleur de la toile non traitée.

Una combinación de los efectos visuales y táctiles que reproduce la conjunción de la madera y el tejido. Texturas y colores son suaves y natural como el color del lino no tratado.

Комбинация визуальных и тактильных эффектов, которую воспроизводит наложение дерева и ткани. Сюжеты и цвета естественны и натуральны, как и сам необработанный лен.



Lino Delavè 3D
MS CIECA TELAIO EVO
MS PLAIN LEAF EVO FRAME
MS VANTAIL LISSE CADRE EVO
MS LISA MARCO EVO
MS ГЛУХАЯ КОРОБ EVO



Lino Delavè 3D
RFX CIECA TELAIO DESIGN 2015
RFX PLAIN LEAF DESIGN 2015 FRAME
RFX VANTAIL LISSE CADRE DESIGN 2015
RFX LISA MARCO DESIGN 2015
RFX ПЛУХАЯ КОРОБ DESIGN 2015



Lino Delavè 3D

RFX VETRO ASIMMETRICO TELAIO DESIGN 2015
RFX ASYMMETRIC GLASS DESIGN 2015 FRAME
RFX VITRAGE ASYMETRIQUE CADRE DESIGN 2015
RFX VIDRIO ASIMÉTRICO MARCO DESIGN 2015
RFX CTEKAO ASIMMETRICO KOPOB DESIGN 2015



Lino Delavè 3D

DMT CIECA SCORREVOLE INTERNO MURO MOSTRE MOSTRE SEMIFILO DA MM 100

DMT PLAIN LEAF INTERNAL SLIDING DOOR ARCHITRAVES FILOLUCE SEMI-FLUSH ARCHITRAVES OF MM 100

DMT VANTAIL LISSE COULISSANTE INTERNE COUVRES JOINTS FILOLUCE COUVRE JOINTS SEMI - ALIGNÉS DE MM 100

DMT LISA PUERTA CORREDERA INTERIOR MOLDURAS FILOLUCE MOLDURAS SEMIFILO MM 100

DMT ГЛУХАЯ КУПЕ В СТЕНУ КОМПЛАНАРНЫЕ НАЛИЧНИКИ MOSTRE SEMIFILO DA MM 100

La combinazione delle trame tessili e dell'effetto legno



The combination of textile textures and wood effect
La combinaison de la trame du tissu et l'effet du bois
La combinación de texturas y del efecto madera
Комбинация тканевых сюжетов и эффекта дерева

Lino Delavè 3D





Wengé

Scuro quasi da sembrare nero ma con una gamma di colori che include tutte le sfumature profonde dei toni bruni, decorate da striature sottili e fitte.

Dark as to appear almost black but with a range of colours which includes all shades of deep brown tones, decorated with thin and thick stripes.

Sombre, presque noir mais avec une gamme de couleurs qui comprend toutes les nuances de tons bruns profonds, décoré avec rayures minces et épaisses.

Oscuro como si fuera casi negro pero con una gama de colores que incluye todas las sombras de color marrón oscuro, decorado con rayas finas.

Темный почти что черный, но со всей гаммой цветов, включающей всю глубину оттенков коричневых тонов, украшенный тонкими и частыми бороздками.



Wengé
MS CIECA TELAIÓ DESIGN 2015
MS PLAIN LEAF DESIGN 2015 FRAME
MS VANTAIL LISSE CADRE DESIGN 2015
MS LISA MARCO DESIGN 2015
MS ГЛУХАЯ КОРОБЬ DESIGN 2015





Wenge

MS CON INSERTI ORIZZONTALI 200 TELAIO ETEREA LINE 2015 A SPINGERE E TIRARE

MS WITH HORIZONTAL INSERTS 200 ETEREA LINE 2015 FRAME PUSH AND PULL

MS AVEC TRAVERSES HORIZONTALES 200 CADRE ETEREA LINE 2015 POUSSER ET TIRER

MS CON INSERTOS HORIZONTALES 200 MARCO ETEREA LINE 2015 EMPUJAR Y TIRAR

MS С ГОРИЗОНТАЛЬНЫМИ МОЛДИНГАМИ 200 КОРОБ ETEREA LINE 2015 ОТКРЫВАНИЕ А СПИНГЕРЕ И ТИРАРЕ



Wengé
DMT CIECA VERSIONE PIEGA TELAIO STANDARD
DMT PLAIN LEAF PIEGA VERSION STANDARD FRAME
DMT VANTAIL LISSE MODÈLE PIEGA CADRE STANDARD
DMT LISA VERSIÓN PIEGA CUADRO ESTÁNDAR
DMT ГЛУХАЯ ВЕРСИЯ PIEGA КОРОБ STANDARD

I toni caldi del marrone incontrano le gradazioni del nero

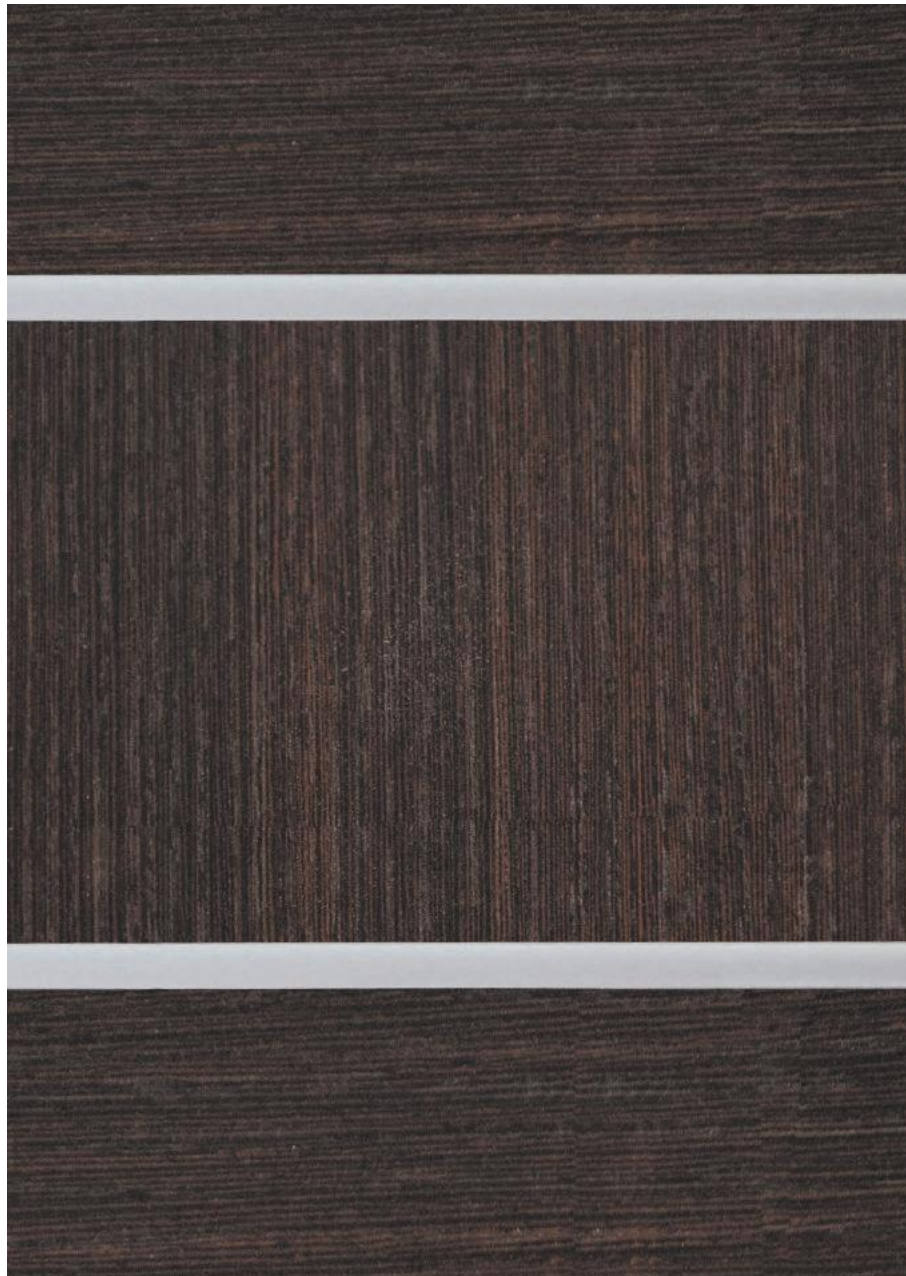

The warm tones of brown meet the shades of black
Les tons chauds du brun rencontrent les nuances du noir
Los tonos cálidos del marrón se encuentran con los tonos del negro
Теплые тона коричневого с оттенками черного

Wengé



mod. LN



mod. MS



mod. RFX



mod. RPY



mod. DMT



mod. INF



mod. MS VETRO STANDARD



mod. VETRO SIMMETRICO



mod. VETRO ASIMMETRICO



mod. VETRO SMALL
VETRO COMPLANARE



Noce Nazionale

e Nazionale

Inconfondibile, affidabile e versatile, il noce nazionale è il colore della tradizione con i suoi marroni caldi misti a leggere tendenze al nero.

Unique, reliable and versatile, the Italian walnut is the colour of tradition with its warm browns mixed to light black tones.

Unique, fiable et polyvalent, le noyer italien est la couleur de la tradition avec ses bruns chauds mélangés à des tons noirs légers.

Inconfundible, fiable y versátil, el noce nazionale es el color de la tradición, con sus marrones cálidos mixtos y ligeras tendencias al negro.

Универсальный и знакомый всем посе nazionale – это цвет традиций с его оттенками тёплого коричневого с легким намеком на стремление к черному.



Noce Nazionale
LN CIECA TELAIO STANDARD
LN PLAIN LEAF STANDARD FRAME
LN VANTAIL LISSE CADRE STANDARD
LN LISA CUADRO ESTÁNDAR
LN ПЛУХАЯ КОРОБ STANDARD



Noce Nazionale

DMT CIECA TELAIO SCORREVOLE SCRIGNO MOSTRE STANDARD
DMT PLAIN LEAF SLIDING DOOR STANDARD ARCHITRAVES
DMT VANTAIL LISSE COULISSANTE COUVRES JOINTS STANDARD
DMT LISA CORREDERA MOLDURAS ESTÁNDAR
DMT ПЛУХАЯ КОРОБ КУПЕ SCRIGNO НАЛИЧНИКИ STANDARD





Noce Nazionale

- INF CIECA TELAIO STANDARD
- INF PLAIN LEAF STANDARD FRAME
- INF VANTAIL LISSE CADRE STANDARD
- INF LISA CUADRO ESTÁNDAR
- INF ГЛУХАЯ КОРОБ STANDARD

Il colore rassicurante della tradizione italiana



The comforting colour of the Italian tradition
La couleur réconfortante de la tradition italienne
El color tranquilizador de la tradición italiana
Убедительный цвет итальянской традиции

Noce Nazionale



mod. LN



mod. MS



mod. RFX



mod. RPY



mod. DMT



mod. INF



mod. VETRO STANDARD



mod. VETRO SIMMETRICO



mod. VETRO ASIMMETRICO



mod. VETRO SMALL
VETRO COMPLANARE



MANIGLIE \ HANDLES \ POIGNÉES \ MANIJAS \ РУЧКИ



DUBLIN

Alluminio Argento
Cromo Lucido
Oro Lucido



BASICA

Argento
Bronzo
Titanio
Ottone



LOS ANGELES

Cromo Satinato
Cromo Lucido
Oro Lucido



QUADRA

Cromo Satinato
Cromo Lucido
Oro Lucido

mod. BICOLORE

Cromo Satinato / Cromo Lucido
Oro Lucido / Satinato



MORIBORD

Alluminio Argento
Cromo Lucido
Oro Lucido



SICURA

Acciaio Inox
PVC Nera
PVC B.ca
Alluminio Argento



VITTORIA

Ottone Lucido
Cromo Satinato
Cromo Lucido



SINUOSA

Cromo Satinato
Cromo Lucido
Oro Lucido
Bronzo



VALENCIA

Ottone Lucido



DIANA

Cromo Satinato
Cromo Lucido
Super Inox Satinato
Super Antracite Satinato



PLANET Q

mod. BICOLORE

Cromo Satinato
Cromo Lucido
Oro Lucido

Cromo Satinato / Cromo Lucido
Oro Lucido / Satinato



TREND

Cromo Satinato
Cromo Lucido



olmo artico



rovere city 3D



olmo baltico



rovere mocaccino 3D



olmo deserto

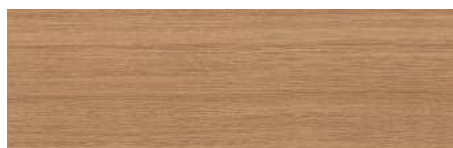

rovere naturale 3D



bianco scultura

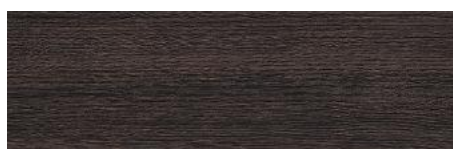

rovere moka 3D



bianco



lino delavé 3D



bianco frassino



wengé



rovere provenza 3D

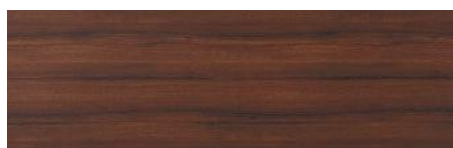

noce nazionale



UN INSERTO ORIZZONTALE



DUE INSERTI ORIZZONTALI



TRE INSERTI ORIZZONTALI



QUATTRO INSERTI ORIZZONTALI



INSERTI ORIZZONTALI 120



INSERTI ORIZZONTALI 200



UN INSERTO VERTICALE LATO
MANIGLIA



UN INSERTO VERTICALE LATO
CERNIERA



DUE INSERTI VERTICALI

*Applicazione inserti valido per i modelli LN e MS in tutti i decorati
 Inserts application good for models LN and MS in all decors
 Application des inserts bonne pour les modèles LN et MS tous les couleurs
 Aplicación de insertos bueno para modelos LN y MS todos los colores
 использование молдингов для моделей LN и MS

VETRI SATINATI DECORATI \ SATIN GLASS WITH DECOR \ VITRAGE AVEC DÉCOR SATINÉ
 VIDRIO SATINADO CON DECORACIÓN \ САТИНИРОВАННЫЕ И ЦВЕТНЫЕ СТЕКЛА



mod. MODENA



mod. PISA



mod. ROMA



mod. TORINO



mod. ANCONA



mod. PERUGIA



mod. CHIETI



mod. PARMA



mod. MILANO



mod. PALERMO



mod. FIRENZE



mod. NAPOLI



mod. GENOVA



mod. PESCARA



mod. VENEZIA con Murine



MADRAS UADI



MADRAS FLOS



MADRAS FILI

VETRI SATINATI COLORATI \ SATIN COLORED GLASS \ VITRAGE COLORÉ SATINÉ
VIDRIO COLOREADO SATINADO \ САТИНИРОВАННЫЕ И ЦВЕТНЫЕ СТЕКЛА

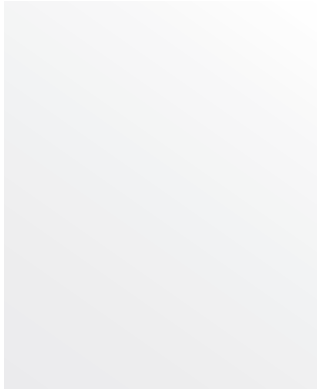

col. TRASPARENTE



col. BIANCO SATINATO



col. BLU SATINATO



col. BRONZO SATINATO



col. VERDE SATINATO



col. ROSA SATINATO



col. GRIGIO SATINATO

TELAIO EVO

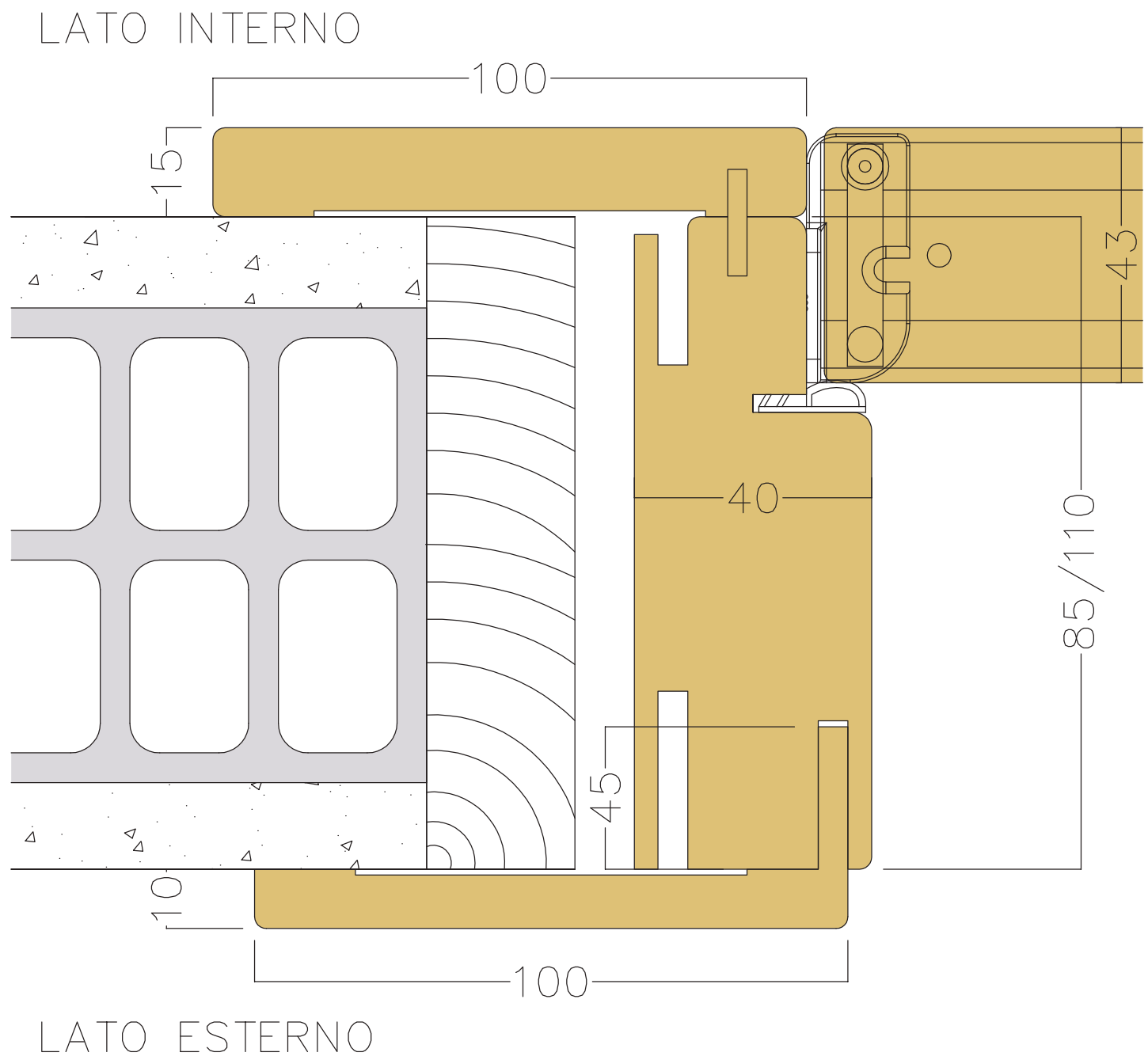

150* (disponibile solo su alcune essenze)

TELAIO EVO - SEZIONE mm (110 - 150)

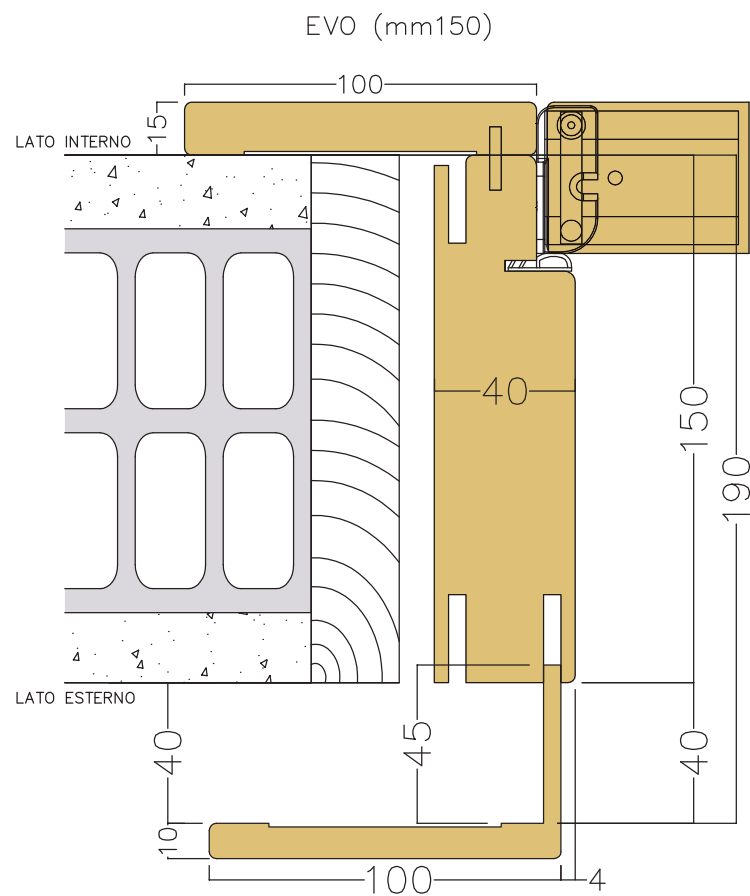
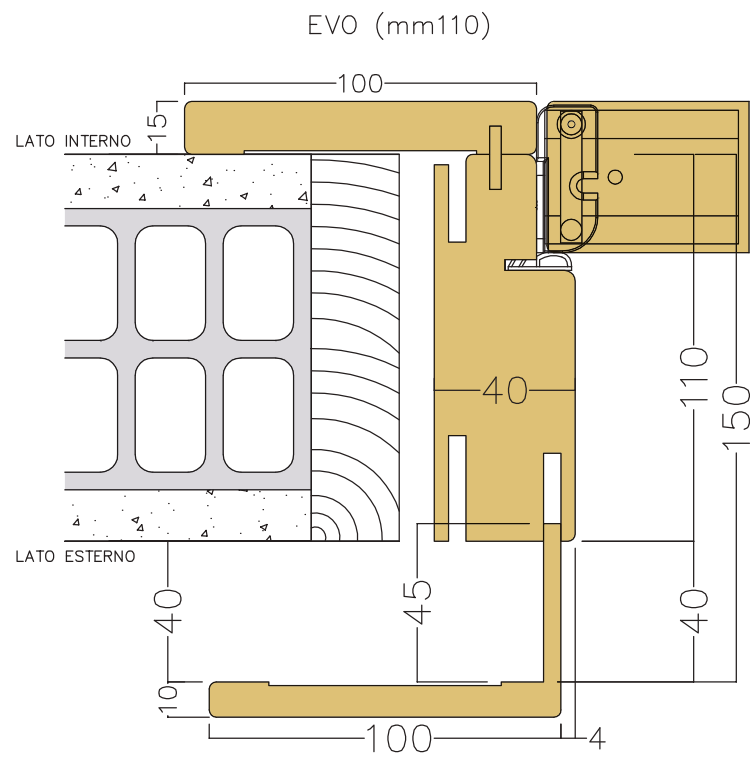

LATO INTERNO

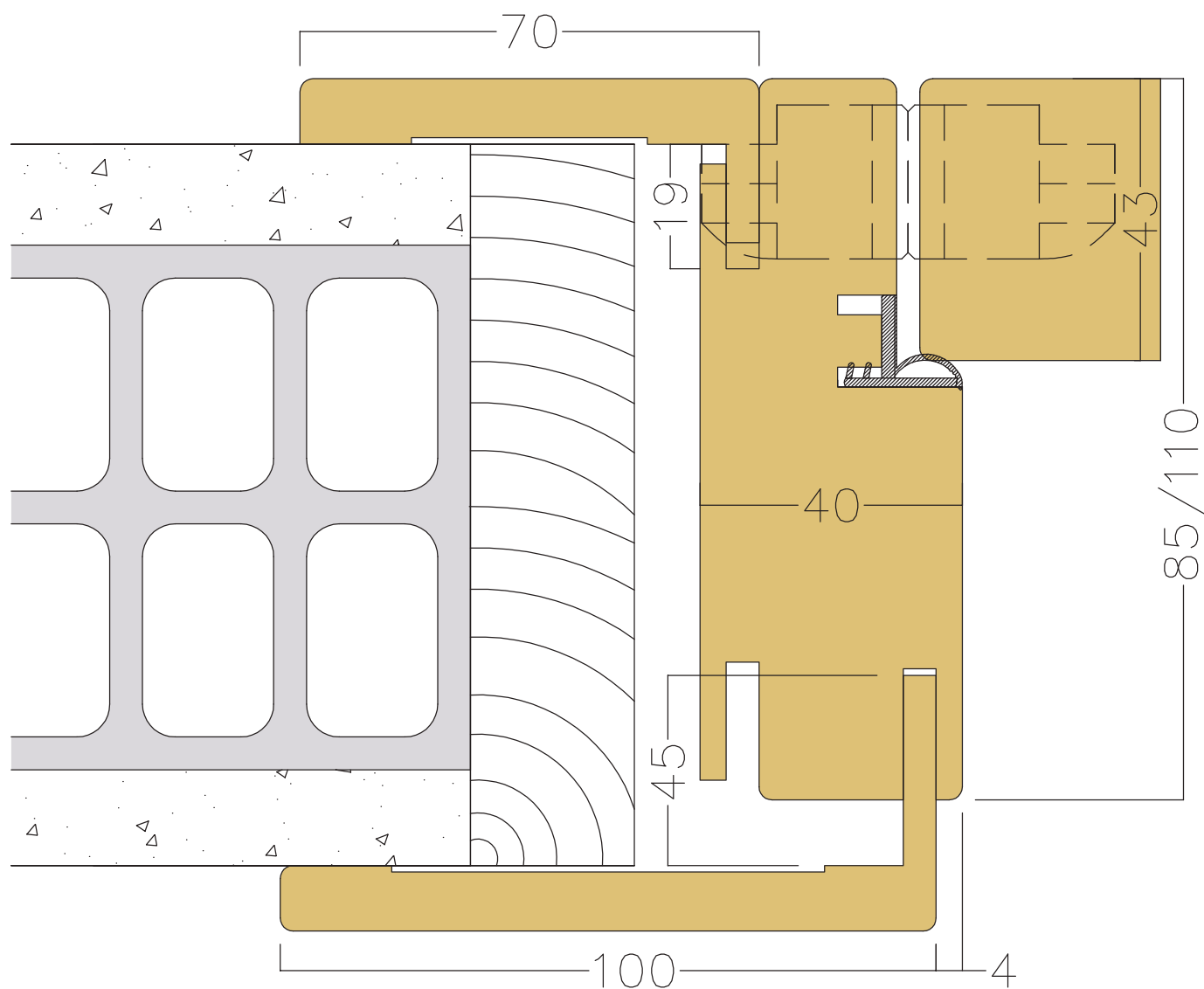

LATO ESTERNO

150* (disponibile solo su alcune essenze)

TELAIO DESIGN 2015 - SEZIONE mm (110 - 150)

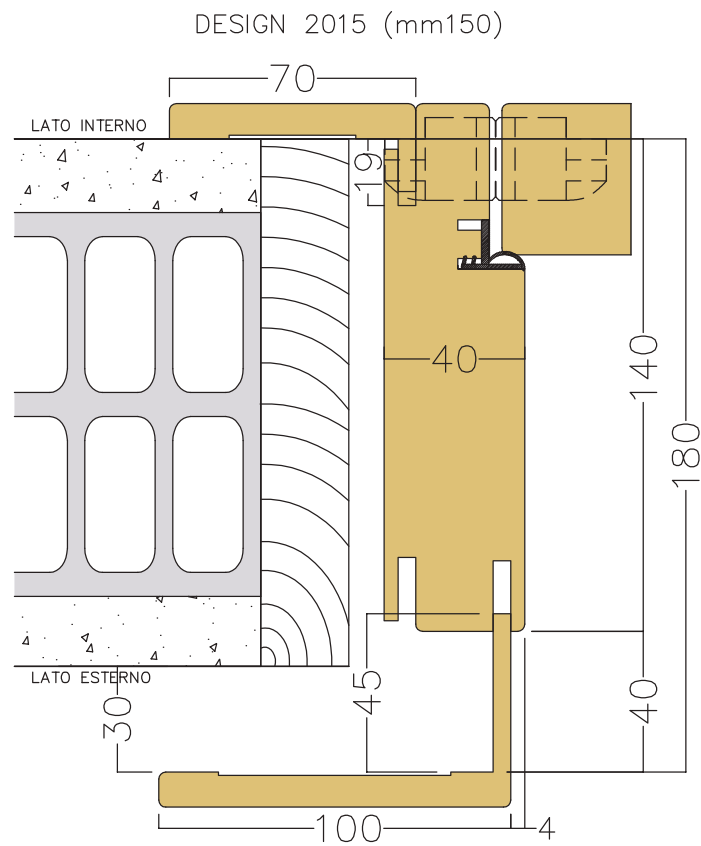
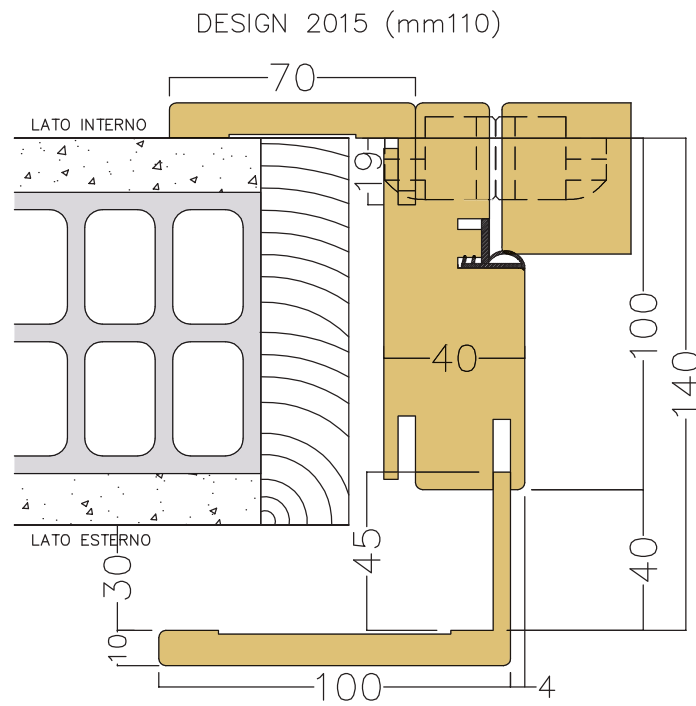

TELAIO ETEREA LINE A SPINGERE 2015

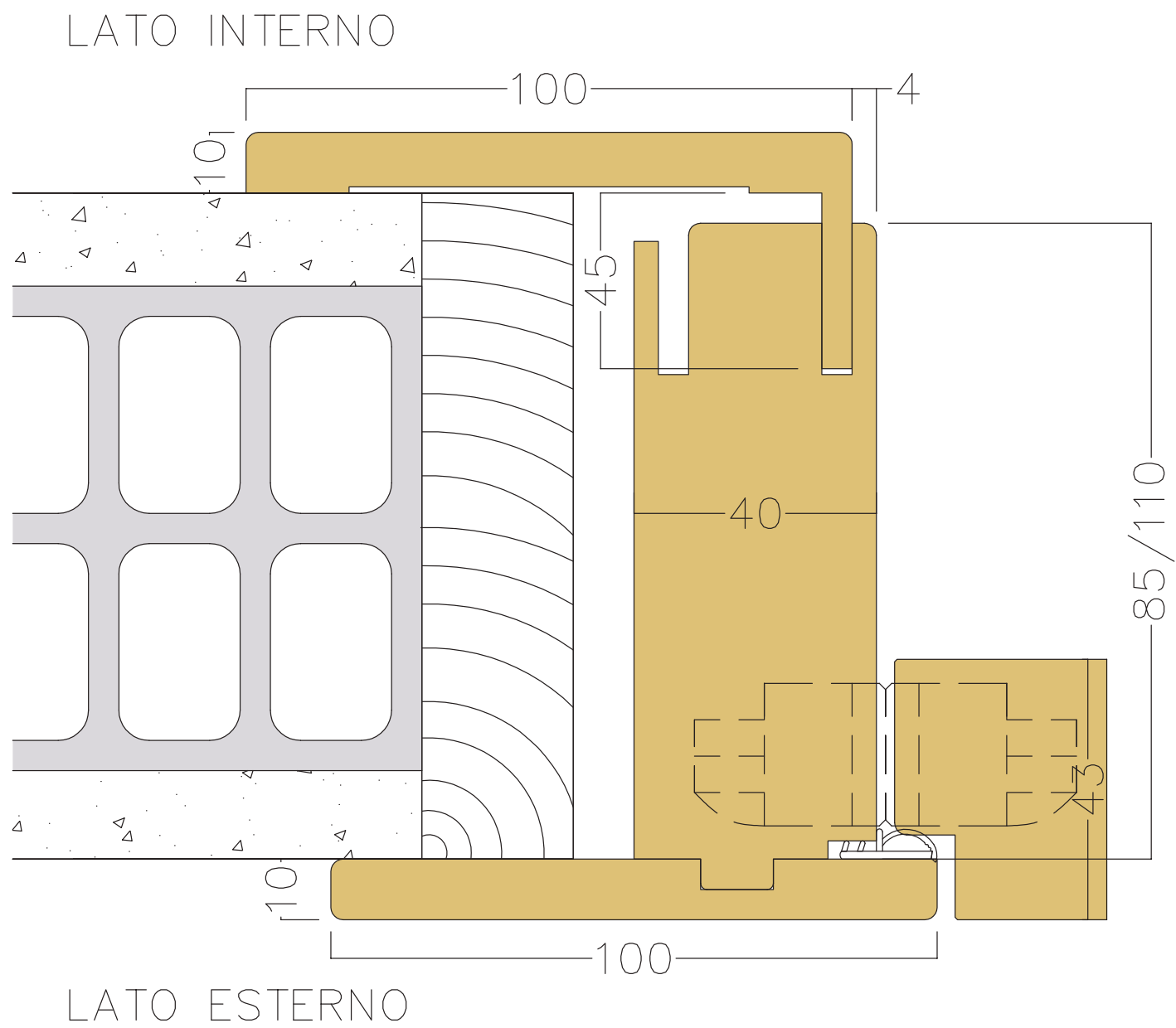

150* (disponibile solo su alcune essenze)

TELAIO ETEREA LINE A SPINGERE 2015 - SEZIONE mm (110 - 150)

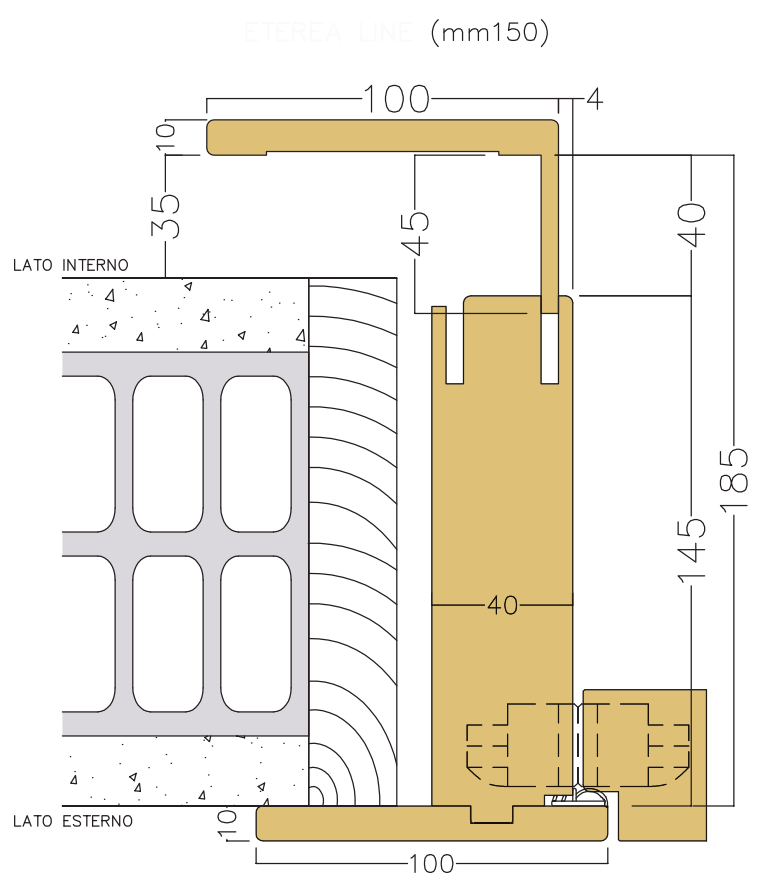
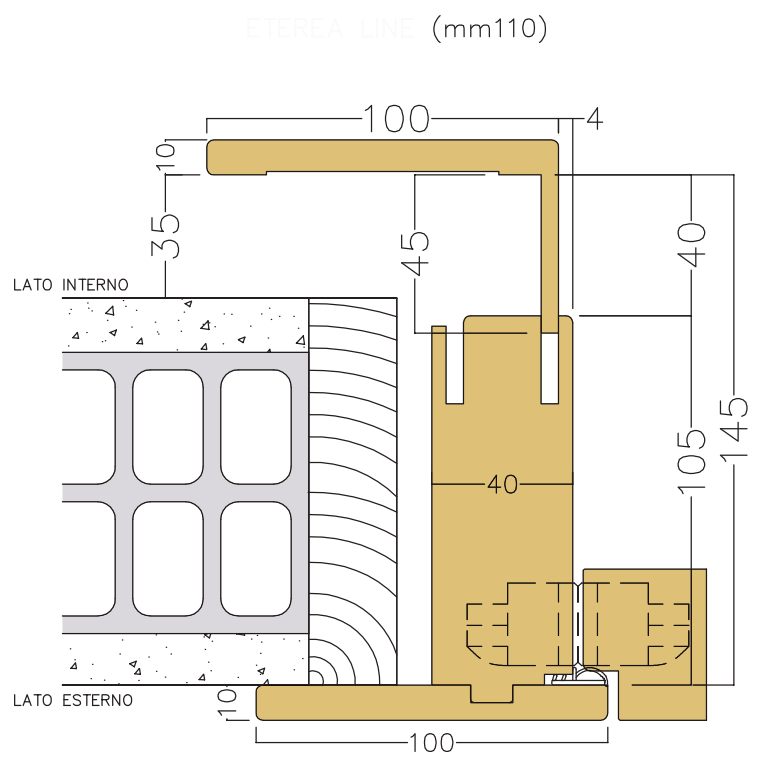

TELAIO ETEREA LINE A TIRARE 2015 - SEZIONE mm (110 - 150)

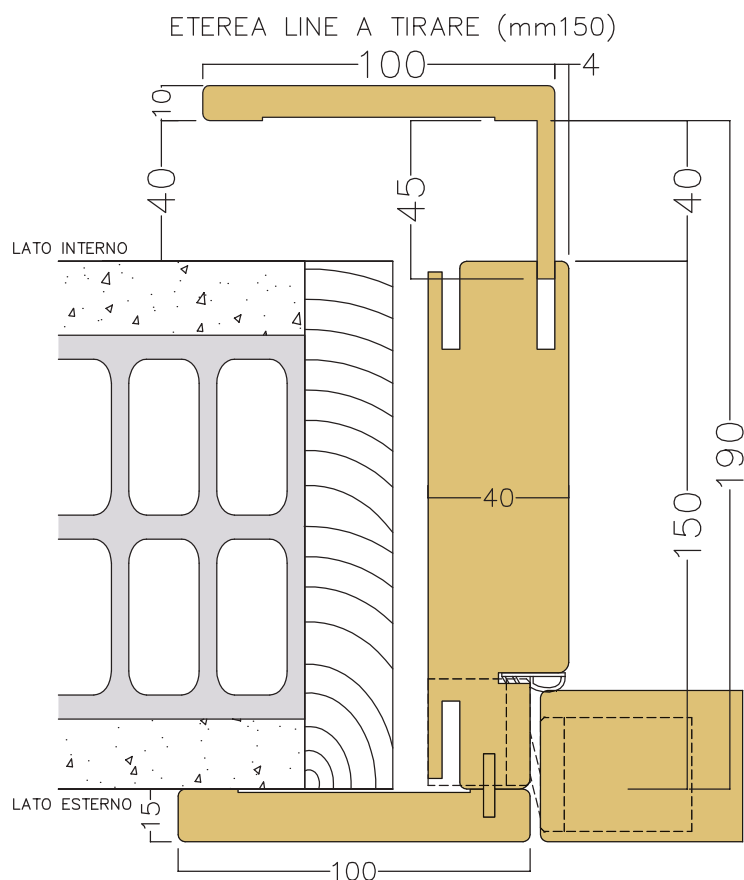
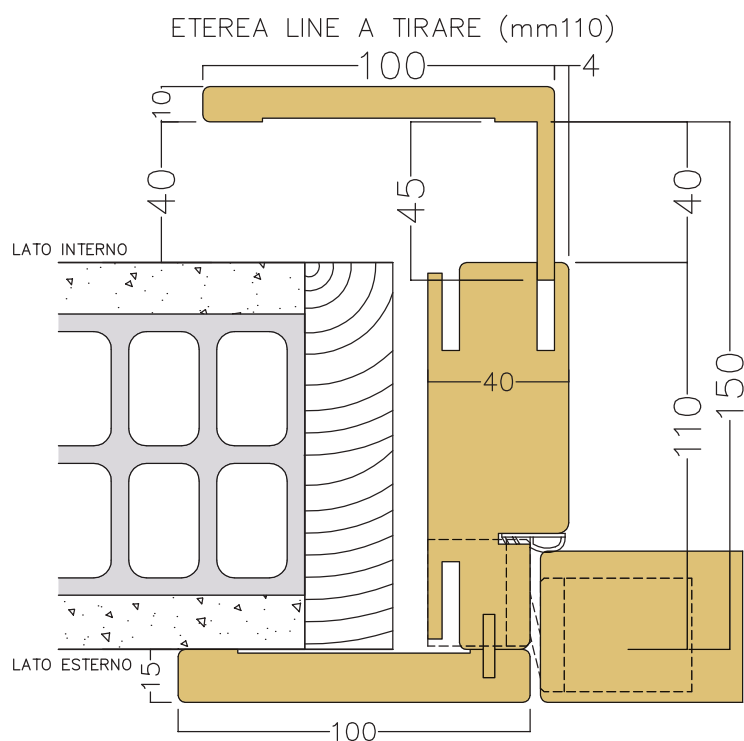

TELAIO STANDARD

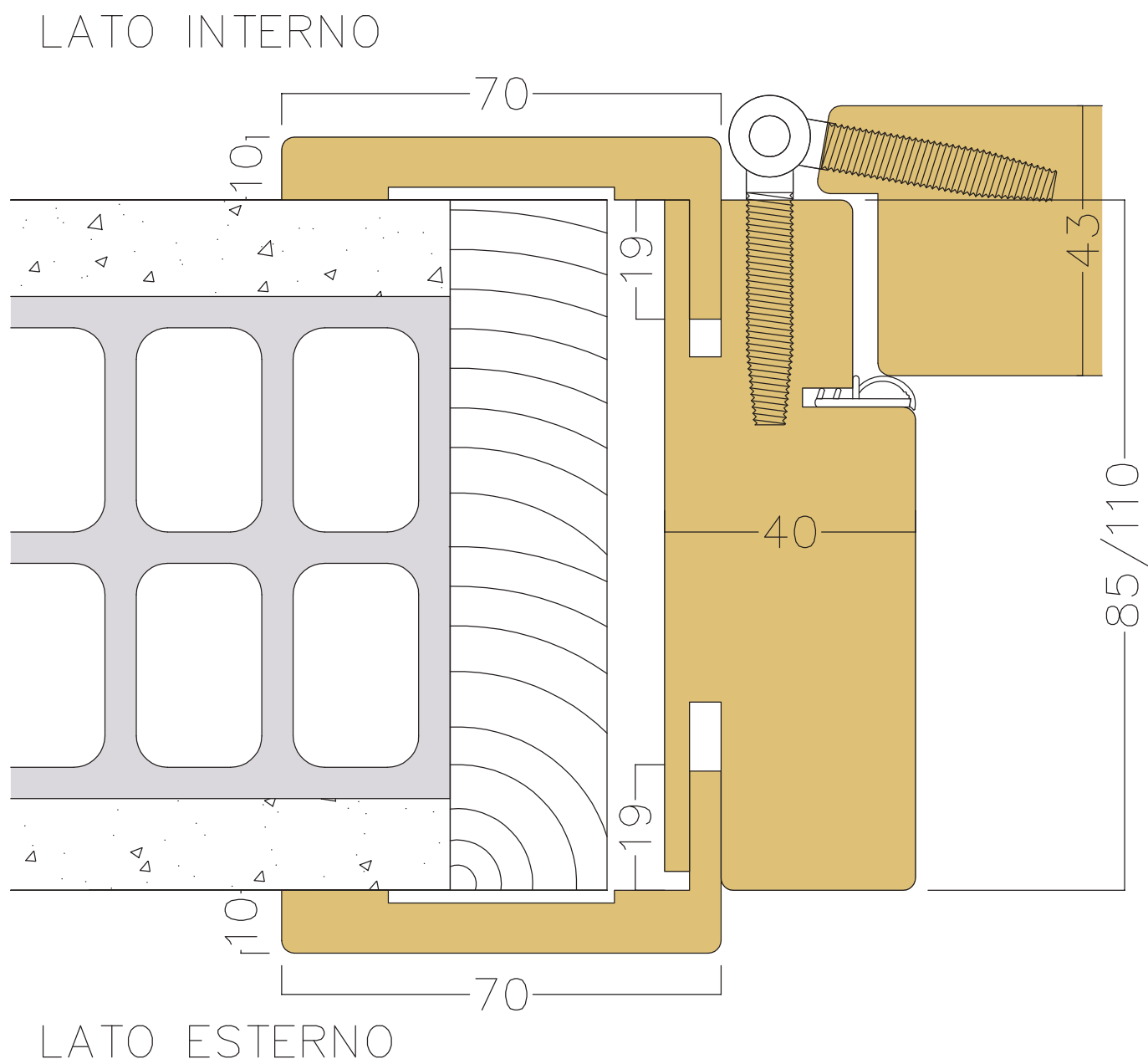

150* (disponibile solo su alcune essenze)

TELAIO STANDARD - SEZIONE mm (110 - 150)

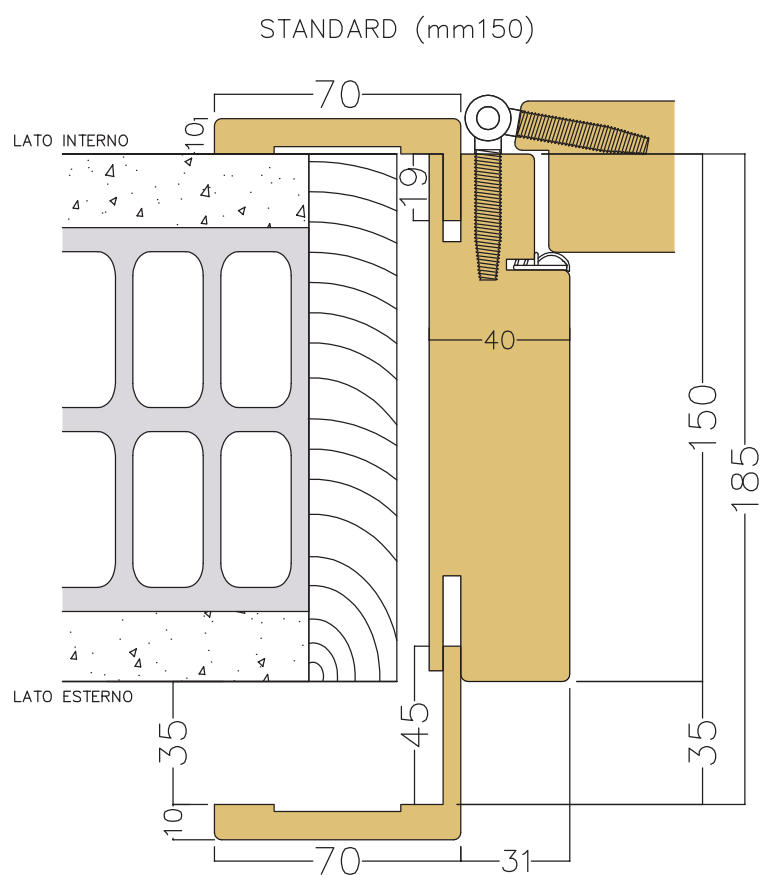
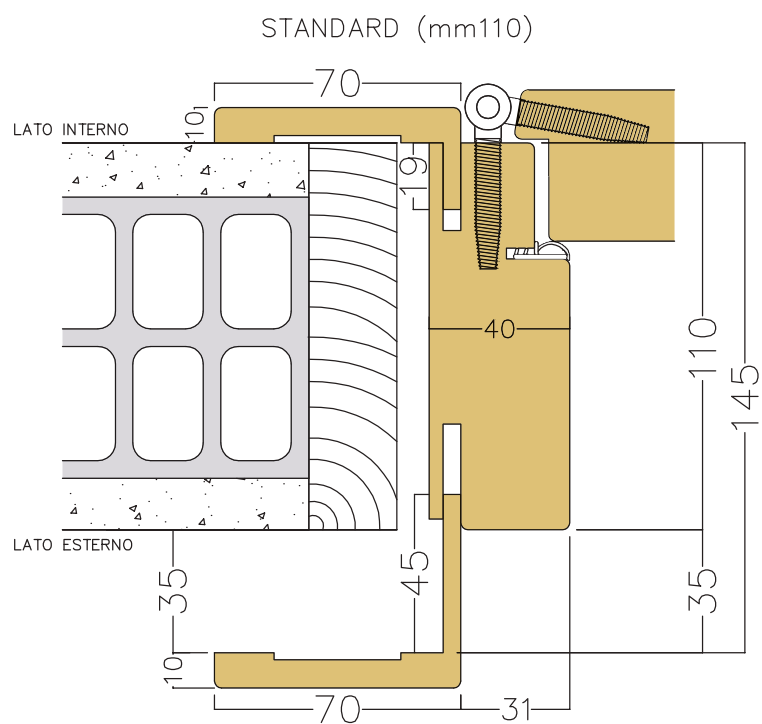

TELAIO MIMETICA 50 a spingere su intonaco

LATO INTERNO

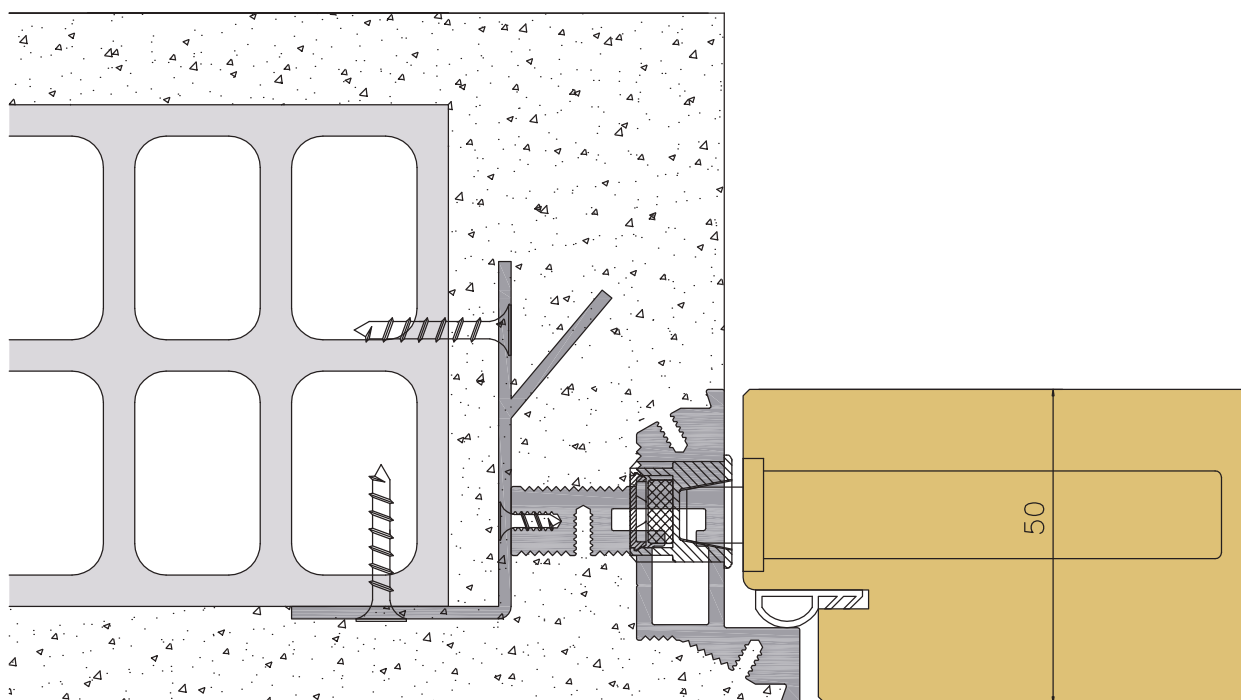

LATO ESTERNO

TELAIO MIMETICA 50 a tirare su intonaco

LATO INTERNO

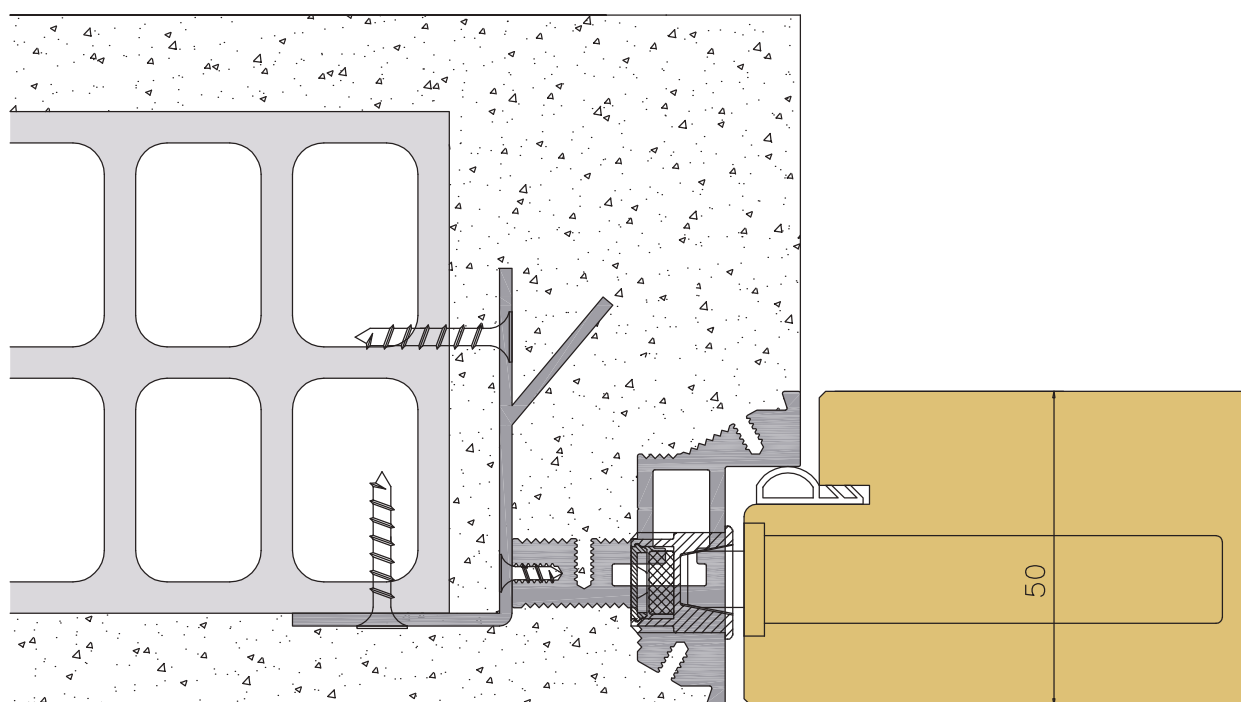

LATO ESTERNO

PROFILO DI RACCORDO IN ALLUMINIO PER TELAIO MIMETICA 50 a spingere su cartongesso

LATO INTERNO

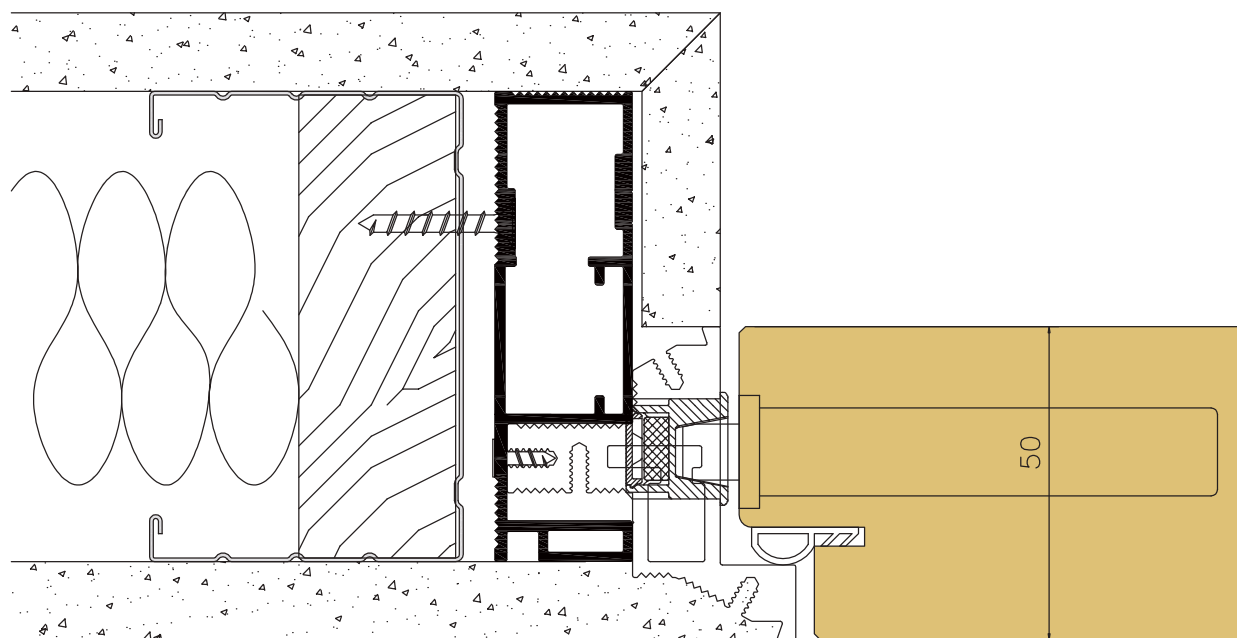

LATO ESTERNO

PROFILO DI RACCORDO IN ALLUMINIO PER TELAIO MIMETICA 50 a tirare su cartongesso

LATO INTERNO

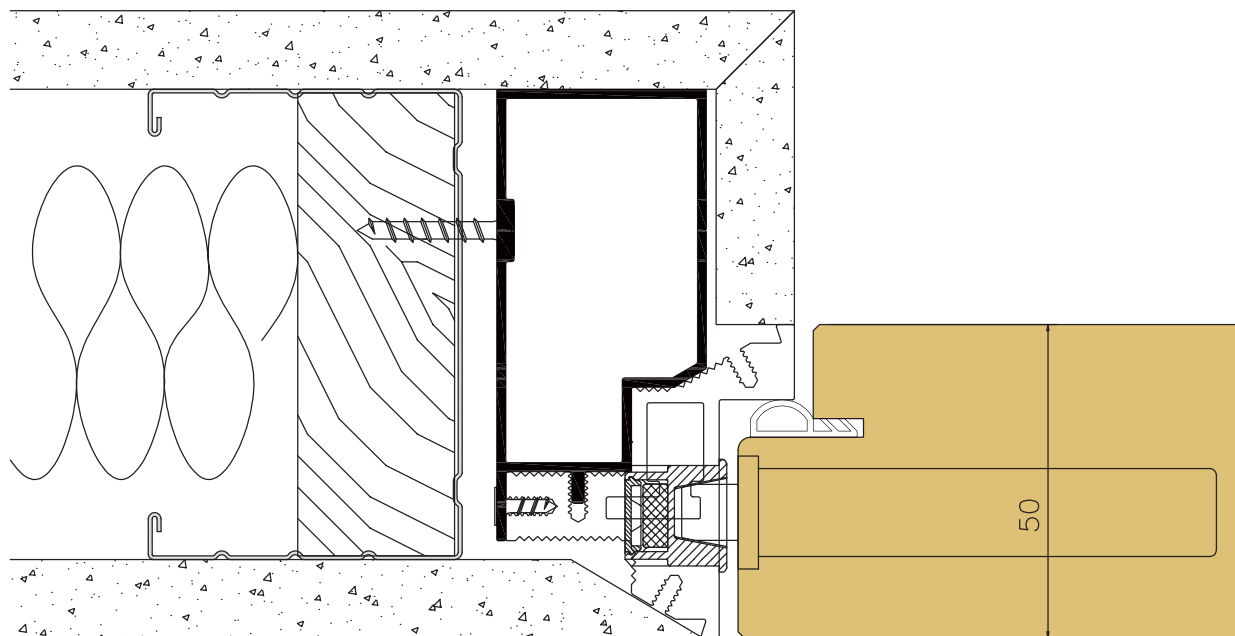

LATO ESTERNO

LE IMMAGINI PRESENTI NEL CATALOGO SONO DA RITENERSI PURAMENTE ILLUSTRATIVE. LE EVENTUALI DIFFORMITÀ RISCOSTRATE NELLE ESSENZE, NEI COLORI O NELLE LAVORAZIONI, VANNO INTESE COME ELEMENTO DI ARTIGIANALITÀ E VANNO ATTRIBUITE ALLE CARATTERISTICHE INTRINSECHE DEL LEGNO.

L'IMPEGNO DELLA PAIL È COMUNQUE QUELLO DI MANTENERE INVARIATA L'ESTETICA E LA QUALITÀ STRUTTURALE DI OGNI MODELLO.

THE IMAGES IN THE CATALOGUE ARE PURELY ILLUSTRATIVE. ANY DISCREPANCIES FOUND IN THE ESSENCES, COLOURS OR WORKMANSHIP ARE TO BE UNDERSTOOD AS AN ELEMENT OF CRAFTSMANSHIP AND CAN BE ATTRIBUTED TO THE INTRINSIC CHARACTERISTICS OF THE WOOD.

PAIL'S COMMITMENT IS STILL TO MAINTAIN THE SAME AESTHETIC AND STRUCTURAL QUALITY OF EACH MODEL.

LES IMAGES DANS LE CATALOGUE SONT PUREMENT ILLUSTRATIVES. TOUT ÉCART DANS LES ESSENCES, DE COULEURS OU DE FABRICATION DOIVENT ÊTRE COMPRIS COMME UN ÉLÉMENT DE L'ARTISANAT ET PEUVENT ÊTRE ATTRIBUÉES À DES CARACTÉRISTIQUES INTRINSÈQUES DU BOIS.

L'ENGAGEMENT DE PAIL EST TOUJOURS DE MAINTENIR LA MÊME QUALITÉ ESTHÉTIQUE ET STRUCTURELLE DE CHAQUE MODÈLE.

LAS IMÁGENES EN EL CATÁLOGO TIENEN UN CARACTER PURAMENTE PARA FINES ILUSTRATIVOS. CUALQUIER DISCREPANCIAS ENCONTRADAS EN LAS ESENCIAS, COLORES O MADERA, DEBERÍA ENTENDERSE COMO UN ELEMENTO DE LA ARTESANÍA, Y SE PUEDE ATRIBUIR A LAS CARACTERÍSTICAS INTRÍNSECAS DE LA MADERA.

EL COMPROMISO DE PAIL ES, SIN EMBARGO, DE MANTENER SIN CAMBIOS LA CALIDAD ESTÉTICA Y ESTRUCTURAL DE CADA MODELO.

РИСУНКИ, ПРЕДСТАВЛЕННЫЕ В КАТАЛОГЕ, ПРЕДСТАВЛЯЮТ СОБОЙ ИСКЛЮЧИТЕЛЬНО НАГЛЯДНЫЙ МАТЕРИАЛ, И ПОДРАЗУМЕВАЕТСЯ, ЧТО ЛЮБЫЕ РАСХОЖДЕНИЯ В МАТЕРИАЛЕ, ЦВЕТЕ ИЛИ ОБРАБОТКЕ ЯВЛЯЮТСЯ СЛЕДСТВИЕМ РЕМЕСЛЕННОГО СПОСОБА ОБРАБОТКИ, А ТАКЖЕ ОСОБЕННОСТЕЙ НАТУРАЛЬНОГО ДЕРЕВА. В ЛЮБОМ СЛУЧАЕ ЗАДАЧА ФАБРИКИ PAIL ЗАКЛЮЧАЕТСЯ В СОХРАНЕНИИ ЭСТЕТИКИ И КОНСТРУКТИВНОГО КАЧЕСТВА КАЖДОЙ МОДЕЛИ.

Progetto Grafico: puntografica.biz

Art director: Gabriele Vacca

Testi: loscrivoio.it

Photo: Zeronove



www.pailserramenti.com

MADE IN ITALY